

**Updated Mineral Resource Estimate
San Luis Project, Ancash Department, Perú**



Prepared for

**Silver Standard Resources, Inc.
Suite 1180, 999 West Hastings Street
Vancouver, British Columbia, Canada V6C 2W2**

And

**Esperanza Silver Corporation
1580 Lincoln Street, Suite 680
Denver, CO 80203**

Prepared by

**Resource Modeling Incorporated
1960 West Muirhead Loop
Tucson, AZ 85737**

And

**Resource Evaluation Incorporated
2475 North Coyote Drive
Tucson, AZ 85745**

January 9, 2009

Table of Contents

Section	Page
1.0 SUMMARY	1
1.1 Project Location, Description, Physiography, Climate and History....	1
1.2 Regional and Local Geology, Deposit Type, and Mineralization.....	2
1.2.1 Regional Geology	2
1.2.2 Local Geology.....	2
1.2.3 Deposit Type and Mineralization.....	3
1.3 Status of Exploration, Development, and Operations.....	3
1.4 Estimate of Mineral Resources	4
1.5 Conclusions and Recommendations.....	5
1.5.1 Conclusions.....	5
1.5.2 Recommendations	6
2.0 INTRODUCTION AND TERMS OF REFERENCE	7
3.0 RELIANCE ON OTHER EXPERTS.....	9
4.0 PROJECT LOCATION AND DESCRIPTION	10
4.1 Project Location	10
4.2 Project Description.....	11
5.0 ACCESSIBILITY, CLIMATE, LOCAL RESOURCES, INFRASTRUCTURE AND PHYSIOGRAPHY	14
5.1 Accessibility	14
5.2 Climate	14
5.3 Local Resources and Infrastructure	14
5.4 Physiography.....	14
6.0 HISTORY	16
7.0 GEOLOGIC SETTING	17
7.1 Regional Geology	17
7.2 Local Geology.....	20
8.0 DEPOSIT TYPE	24
9.0 MINERALIZATION	25
9.1 Ayelén Vein	26
9.2 Inéz Vein	29
10.0 EXPLORATION	30
10.1 2005 Exploration Program	30
10.2 2006 Exploration Program	30
10.3 2007 Exploration Program	33
11.0 DRILLING	34
11.1 Diamond Core Data	34
11.2 Results of the Drilling Programs.....	37
11.3 Sample Length Versus True Thickness.....	38
11.4 Orientation of Mineralization	38
12.0 SAMPLING METHOD AND APPROACH	39

12.1	Description of Sampling Methods.....	39
12.2	Drilling and Sampling Factors.....	39
12.3	Core vs. Chip-Channel Sample Quality	39
12.4	Geologic Controls – High-grade Zones	42
12.5	Summary of Relevant Samples	43
13.0	SAMPLE PREPARATION, ANALYSES AND SECURITY.....	44
13.1	Sample Preparation Procedures	44
13.2	Sample Analytical Procedures	44
13.3	Sample Security and Chain of Custody Procedures	45
14.0	DATA VERIFICATION.....	46
14.1	Electronic Database Verification.....	46
14.2	Review of QA/QC Results	48
15.0	ADJACENT PROPERTIES	51
16.0	MINERAL PROCESSING AND METALLURGICAL TESTING.....	52
16.1	Metallurgical Composite Samples	52
16.2	Test Procedures	53
16.3	Test Results	54
16.4	Conclusions	55
17.0	MINERAL RESOURCE AND MINERAL RESERVE ESTIMATES.....	56
17.1	Sample Data.....	56
17.2	Geologic Data	56
17.3	Topographic Data.....	56
17.4	Bulk Density Data.....	56
17.5	Assay Statistics.....	58
17.6	Grade Capping.....	64
17.7	Compositing	68
17.8	Vein Wireframe Construction	68
17.9	High-grade Wireframes	69
17.10	Variography	70
17.11	Grade Estimation.....	72
17.12	Model Verification.....	74
17.13	Resource Classification.....	79
17.14	Mineral Resource Tabulation	79
18.0	OTHER RELEVANT DATA AND INFORMATION	81
19.0	INTERPRETATION AND CONCLUSIONS	82
19.1	Interpretation	82
20.0	RECOMMENDATIONS	83
21.0	REFERENCES	84
22.0	DATE AND SIGNATURE PAGE	85
23.0	ADDITIONAL REQUIREMENTS FOR TECHNICAL REPORTS ON DEVELOPMENT PROPERTIES AND PRODUCTION PROPERTIES.....	87

List of Figures	Page
Figure 4-1: San Luis Project Location Map.....	10
Figure 7-1: Regional Geology	19
Figure 7-2: Property Geology Map.....	21
Figure 9-1: Satellite View of the Major Veins of the San Luis Project.....	25
Figure 9-2: Multi-Stage Quartz Banding	26
Figure 9-3: Geologic Plan Map of Ayelén and Inéz Veins.....	28
Figure 10-1: Trench with Spray-Painted Locations of Individual Channel Samples	31
Figure 10-2: Locations of 2006 Channel Samples on Central Portion of Ayelén Vein	32
Figure 11-1: Drill Hole Plan Map.....	36
Figure 12-1: Ayelén Au QQ Plot – Core vs. Chip Channel	41
Figure 12-2: Ayelén Ag QQ Plot – Core vs. Chip-Channel	42
Figure 14-1: Quarter Core Duplicate Sample Results - Gold.....	50
Figure 17-1: Au Box Plot for Select Lithologic Units.....	63
Figure 17-2: Ag Box Plot for Select Lithologic Units.....	63
Figure 17-3: Ayelén Au Cumulative Probability Plot	64
Figure 17-4: Ayelén Ag Cumulative Probability Plot	66
Figure 17-5: Perspective View of Ayelén and Inéz Veins.....	70
Figure 17-6: Ayelén Down-hole Gold Correlogram.....	71
Figure 17-7: Ayelén Down-hole Silver Correlogram.....	72
Figure 17-8: Block Au Grade Contours – Section 8,960,885 North	75
Figure 17-9: Block Au Grade Contours – 4530 Elevation	76
Figure 17-10: Au Composite vs. Au Block Histogram	77
Figure 17-11: Au Composite vs. Au Block Grades.....	77
Figure 17-12: Ag Composite vs. Ag Block Histogram	78
Figure 17-13: Ag Composite vs. Ag Block Grades.....	78

List of Tables	Page
Table 1-1: San Luis Mineral Resources	5
Table 2-1: List of Abbreviations	8
Table 4-1: List of Mineral Concessions	13
Table 11-1: Summary of Diamond Drill Hole Data.....	35
Table 11-2: Diamond Drill Hole Orientations.....	35
Table 11-3: Summary of Chip-Channel Trenches.....	37
Table 12-1: Paired Core vs. Chip-Channel Sample Grades	40
Table 12-2: Relevant Compositated Samples	43
Table 14-1: Verified Data.....	47
Table 14-2: Database Verification Results.....	47
Table 14-3: Quarter Core Duplicate Sample Statistics.....	49
Table 16-1: Metallurgical Composite Head Grade Analyses.....	52
Table 16-2: Preliminary Metallurgical Test Results	54
Table 17-1: Bulk Density Values by Logged Lithologies.....	57
Table 17-2: Bulk Density Values by Combined Lithologic Units	58
Table 17-3: Au Assay Statistics by Area.....	58
Table 17-4: Au Assay Statistics by Sample Type	59
Table 17-5: Au Assay Statistics by Combined Lithologies.....	59
Table 17-6: Au Assay Statistics by Mineralized Zone.....	60
Table 17-7: Ag Assay Statistics by Area.....	60
Table 17-8: Ag Assay Statistics by Sample Type	61
Table 17-9: Ag Assay Statistics by Rock Type.....	61
Table 17-10: Ag Assay Statistics by Mineralized Zone.....	62
Table 17-11: Ayelén Au Decile Distribution	65
Table 17-12: Ayelén Ag Decile Distribution	67
Table 17-13: Capping Limits.....	67
Table 17-14: Wireframe Volumes.....	69
Table 17-15: San Luis Block Model Extents	72
Table 17-16: Inverse Distance Grade Estimation Parameters.....	73
Table 17-17: San Luis Mineral Resources	80
Table 17-18: Mineral Resources Using a 40 gt Ag Cutoff.....	80

1.0 SUMMARY

Resource Evaluation Inc. (REI) and Resource Modeling Inc. (RMI) were retained by Silver Standard Resources Inc. (Silver Standard) and Esperanza Silver Corporation (Esperanza) to complete an updated mineral resource estimate for the Ayelén and Inéz veins that are part of the volcanic-hosted mineral deposits which comprise the San Luis project, which is located in the District of Shupluy, Yungay Province, Ancash Department, in northern Perú. The purpose of this Technical Report is to provide necessary background information, the results of analyses of technical data, the methodologies and parameters used for the estimation of the Mineral Resource update, and a summary of the Measured, Indicated, and Inferred Mineral Resources for these two veins.

Except for Section 17.0 as noted, this Technical Report relies heavily on information and data provided by Silver Standard. The updated Mineral Resource estimate that is the focus of this report is based on technical data that were collected, recorded, and verified by Silver Standard and Esperanza. In the opinions of REI and RMI, the quality of these data is acceptable. Specific individuals who provided REI and RMI with written data, maps, sections, electronic files, and verbal information include Silver Standard's Ken McNaughton, Ron Burke, Ken Konkin, Zoran Lukic, and Esperanza's William Pincus, Paul Bartos, and Steve Zucker.

All information and data for the completion of Section 16.0 were derived from an unpublished report prepared for Silver Standard by F. Wright Consulting, Inc. "San Luis Gold Silver Project Preliminary Metallurgical Study".

1.1 Project Location, Description, Physiography, Climate and History

The San Luis project is located in the Cordillera Negra of north-central Perú, 513 kilometers north-northwest of Lima and 113 kilometers east of the city of Casma. The project is approximately centered at Longitude 77 47' West and Latitude 9° 23' South, U.T.M. coordinates 8,960,000 m North by 195,000 m East, and consists of thirty-four mineral concessions covering an area of 29,338.3326 hectares. All of the mineral concessions are fully titled and contiguous, but none have been legally surveyed.

The region is mountainous and high in elevation, with valleys and rolling hills interspersed with rugged snow-capped mountains. Elevations range from 3,600 meters (11,811 ft) at the San Luis project campsite to 4,850 meters (15,912 ft) A.M.S.L. at the summit of the nearby Cerro Huilcahuaín. Below 4,000 meters elevation vegetation consists of small deciduous trees, bushes and various grasses while at higher elevations the mountain slopes contain Stipa Ichu grass and various small bushes. The climate in the project area is dry from May to December, when temperatures range from 10° to 22°C. During the rainy season (January to April) temperatures are more moderate but the weather is characterized by occasional heavy rains and abundant fog with hail and snow at higher elevations.

The project site is rural and sparsely populated, with only about 400 inhabitants in each of the nearest towns (Tambra and Pueblo Viejo). Larger population centers near the project site that have available skilled labor and the necessary services for exploration and development of a mining project include Casma, Carhuaz, and Huaraz.

There are no reported historical mineral resources or documented production from the San Luis property. Evidence of past exploration and small scale mining activity is confined to test pits and short adits that probably were related to sporadic searches for high grade gold and silver by local inhabitants.

1.2 Regional and Local Geology, Deposit Type, and Mineralization

1.2.1 Regional Geology

The San Luis property is situated within the Cordillera Negra terrane of the Peruvian Andes. The sedimentary stratigraphy of the region consists (from oldest to youngest) of interbedded mudstones and sandstones of the upper Jurassic Chicama Formation, quartzites, sandstones and shales of the lower Cretaceous Chimú Formation, limestones and calcareous clays of the lower Cretaceous Santa Formation the Carhuaz Formation (sandstones, quartzites, with interbedded mudstones), the Farrat Formation (fine quartzites with interbeds of red mudstone), and a Cretaceous sequence of calcareous rocks of the Pariahuanca, Chulec, and Pariatambo Formations. An angular unconformity separates the sediments from the overlying volcanic Paleocene Calipuy Formation (tuffs, coarse pyroclastics, agglomerates, lavas and sub volcanic intrusions of andesitic/dacitic/rhyolitic composition). Overlying the Calipuy Formation is the Mio-Pliocene Yungay Formation, which is composed of dacitic tuffs and ignimbrites. Intrusive rocks in the region consist of the Cretaceous – Paleocene Coastal batholith and the Mio-Pliocene Cordillera Blanca batholith (both composed of granodiorites and tonalites). Recent surficial deposits in the region are mostly fluvial – glacial in character. Regional structure is related to four stages of crustal deformation – uplift of the Andean belt, followed by the Andean Orogenesis characterized by folding and thrust faulting (which affected the Jurassic and Cretaceous sediments), block faulting (large vertical displacements of basement rocks), and Plio-Pleistocene renewed uplift of the Andean belt.

1.2.2 Local Geology

Local stratigraphy in the San Luis project area is dominated by the Paleocene Calipuy Formation which occurs mainly as flat-lying andesite volcanic sediments consisting of interlayered tuffs, coarse pyroclastic flows, volcanic breccias, agglomerates and lava flows. Fine to coarse-grained andesites overlain by beds of interlayered andesite and volcanic breccia that strike northwesterly and dip from sub-horizontal to 30° southwest are the main hosts for the mineralized structures at San Luis. Other local lithologies include sandstones and fine-grained quartzites interlayered with some clay stones of the lower Cretaceous Carhuaz Formation (exposed as windows in the overlying volcanics) and granodiorites of the Puscao unit of the Coastal batholith, lesser outcrops of granodiorite

and tonalite of the Cordillera Blanca batholith, and a series of rhyolitic sills, dikes, and irregular bodies that occur in intimate association with the San Luis veins.

Structurally, local northwest and north-northwesterly faults have been active since the majority of volcanism ceased but prior to emplacement of the main epithermal veins. However, faulting also occurred during and after vein emplacement, which resulted in the well developed vein breccia textures, tensional openings that allowed subsequent emplacement of rhyodacite dikes, and later brecciation and displacement of both the dikes and veins.

1.2.3 Deposit Type and Mineralization

The San Luis vein system is a typical volcanic-hosted low sulphidation epithermal quartz/precious metal deposit. Vein gangue mineralization consists of quartz, chalcedony, calcite and minor adularia. Gold occurs as electrum and silver is present as acanthite, other silver sulphosalts, and electrum. Other sulphides include trace amounts of pyrite, chalcopryrite, galena and sphalerite. The veins display common epithermal textures including crustiform banding that often displays interlayers of quartz and sulfide minerals. Bands are frequently disrupted, indicating repeated pulses of mineralization. Lattice textures in which calcite crystals have been replaced by quartz and brecciation are also common characteristics. Faulting and fracturing are key elements in the localization of mineralization in the vein system. Ore “shoots” typically occur in dilational zones that are the result of a variety of local stresses, and often these stresses are repeated along the length of a vein structure, resulting in multiple ore-shoots.

The Ayelén vein is the better mineralized of the known vein structures. Trenching and diamond drilling have traced this structure along a strike of 340° to 345° for a length of over 720 meters, with down-dip extensions of more than 325 meters. Surface mapping shows that the vein structure dips -75° to -85° west-southwesterly, but drilling results show that the controlling fault structure(s), sub-surface individual vein segments and post-mineral dikes dip vertically to -80° west-southwesterly. True thicknesses of individual vein segments vary from ten’s of centimeters to more than 10 meters, and average 1.5 to 3.0 meters wide.

The Inéz vein, which is situated approximately 110 m east of the Ayelén vein, strikes northwesterly at 320° to 340° and dips -50° to -75° northeastwardly. The vein outcrops as series of discontinuous resistant ridges for more than 2,200 m along strike, with apparent widths of 2.0 to 7.5 m. However, only a relatively short section of the Inéz vein contains significant amounts of gold and silver, and this section occurs where the Inéz vein is closest to the Ayelén vein.

1.3 Status of Exploration, Development, and Operations

No exploration work took place on the Ayelén and Inéz veins in 2008 since completion of the last NI 43-101 Technical Report on the San Luis Project (Blanchflower – 2007). During 2008, exploration work at San Luis focused on porphyry-style mineralized

occurrences at what is known as the BP zone, located approximately six kilometers southeast of the mineralized shoots on the Ayelén and Inéz veins. Because examination/evaluation of the BP zone exploration activity was not part of the scope of work for the update of the Mineral Resources contained in the Ayelén and Inéz veins (which is the subject of this Technical Report), no descriptions of 2008 exploration work in this area are included.

As of the date of this Technical Report, no development work pertaining to the Ayelén and Inéz Mineral Resources has commenced. The authors note that the SSRI-Esperanza joint venture is currently preparing a feasibility study to address the economic viability of the San Luis project. This study is scheduled to be completed sometime within the first half of 2009. An environmental impact study has been commissioned and is anticipated to be completed near the end of 2009. In addition, the SSRI-Esperanza joint venture is currently negotiating a long term land access agreement.

1.4 Estimate of Mineral Resources

Mineral Resources were estimated for the Ayelén and Inéz veins by the authors using a combination of diamond drill hole and surface chip-channel sample data. Three-dimensional wireframes were constructed for both veins using lithology and precious metal grades. To the extent possible, the wireframes were also based on a geologic interpretation that was completed by Mr. Ken Konkin.

A three pass inverse distance cubed interpolation plan was used to estimate block model gold and silver grades using one-meter-long composite data. Prior to compositing the data, raw gold and silver assays were capped based on a review of cumulative probability plots. Different capping limits were used for the Ayelén and Inéz veins due to differences in the distribution of metal for those veins.

A dynamic anisotropy search strategy was used which matched blocks and composites based on their distance from either the hangingwall or footwall contact of the main Ayelén vein. A nominal number of composites were used to minimize grade smearing. The resultant model shows detailed high-grade mineralized shoots and intervening low-grade and/or waste selvages.

The estimated blocks were classified into Measured, Indicated, and Inferred Resource categories based on distance to data. Measured Resources were only assigned to Ayelén blocks located within 15 meters of surface trench samples. Table 1-1 summarizes Mineral Resources for the San Luis project using a gold equivalent (AuEQV) cutoff grade of 6.0 g/t. Gold and silver metal prices of \$US 600 and \$US 9.25 per troy ounce or an equivalency factor of 65:1.

Table 1-1: San Luis Mineral Resources

Measured Mineral Resources						
Tonnes	Au (g/t)	Ag (g/t)	AuEQV (g/t)	Contained Au	Contained Ag	Contained AuEQV
55,000	34.3	757.6	46.0	61,000	1,345,100	81,700

Indicated Mineral Resources						
Tonnes	Au (g/t)	Ag (g/t)	AuEQV (g/t)	Au Ounces	Ag Ounces	AuEQV Ounces
429,000	20.8	555.0	29.3	287,000	7,658,200	404,800

Measured and Indicated Mineral Resources						
Tonnes	Au (g/t)	Ag (g/t)	AuEQV (g/t)	Au Ounces	Ag Ounces	AuEQV Ounces
484,000	22.4	578.1	31.2	348,100	9,003,300	486,500

Inferred Mineral Resources						
Tonnes	Au (g/t)	Ag (g/t)	AuEQV (g/t)	Au Ounces	Ag Ounces	AuEQV Ounces
20,000	5.6	270.1	9.7	3,600	174,900	6,300

1.5 Conclusions and Recommendations

1.5.1 Conclusions

In the opinion of REI and RMI, the updated Mineral Resource estimation that is the focus of this Technical Report is based on valid assay data, specific gravity data, lithologic and alteration data, and structural data. These data are supported by a sufficient QA/QC program, such that the resulting updated Mineral Resource estimate is a reasonable estimate of the insitu undiluted gold and silver mineralization that could be extracted in the future, given favorable economic conditions. However, it is not certain that any of these Mineral Resources might convert to Proven and Probable Mineral Reserves without additional metallurgical testwork, environmental studies, and economic analyses that include conceptual mine plans and designs, production schedules, detailed operating and capital cost estimates, general and administrative cost estimates, and smelting/refining cost estimates.

1.5.2 Recommendations

- There is very little Inferred material within the currently defined Ayelén vein but a significant portion of the Inéz vein is classified as an Inferred Mineral Resource. The joint venture should review whether additional drilling should be completed on the Inéz vein in order to upgrade the Inferred Mineral Resources to Measured or Indicated categories. The authors note that the gold and silver grades within the currently defined Inéz vein are significantly lower than the main Ayelén vein. Similarly, the mineralized continuity of the Inéz vein is not nearly as consistent as the Ayelén vein. The cost for additional drilling is highly variable and depends on the meterage to be drilled.
- Obtain a more accurate topographic base map using traditional aerial survey methods. This is not a particularly material issue regarding ore tonnage estimates for an underground operation but the detailed topographic data will be required for surface construction activities. The cost for obtained detailed topographic information could range between \$50,000 to \$200,000.
- Consider a “scoping level-type” study as a part of the ongoing feasibility study to address mining methods. In the opinion of the authors, a significant portion of the deposit may be amenable to open pit mining methods. The cost for such a study could range between \$10,000 and \$50,000.
- Complete additional metallurgical studies to determine a potential processing method and flowsheet.

2.0 INTRODUCTION AND TERMS OF REFERENCE

Resource Evaluation Inc. (REI) and Resource Modeling Inc. (RMI) were retained by Silver Standard Resources Inc. (Silver Standard) and Esperanza Silver Corporation (Esperanza) to complete an updated mineral resource estimate for the vein-hosted mineral deposits that are part of the San Luis project, located in the District of Shupluy, Yungay Province, Ancash Department, in northern Perú. RMI's work included receipt, review, and validation of all drill hole data, three-dimensional interpretations of the mineralized veins, analysis of basic statistics, variography, construction of a block model, development of resource estimation and classification parameters, block grade estimation, resource tabulation and validation, and preparations of certain sections of this Technical Report in accordance with Canada National Instrument NI 43-101 and in compliance with Form 43-101F1. REI's work included a visit to the San Luis project site on June 25-26, 2008, for the purpose of reviewing diamond drill core, sampling procedures, data collection procedures, geologic cross sections and plan maps, and the geologic interpretation of the Ayelén and Inéz veins. REI also assisted Resource Modeling Inc. (RMI) with various aspects of the mineral resource estimate update, and preparation of certain sections of this Technical Report in accordance with Canada National Instrument NI 43-101 and in compliance with Form 43-101F1. Mr. Donald Earnest, P.Geol. and President of REI, and Mr. Michael Lechner, P.Geol. and President of RMI, served as the Qualified Persons responsible for preparing certain sections of Technical Report.

The purpose of this Technical Report is to provide technical information related to updated Mineral Resource estimates for the Ayelén and Inéz veins.

Data, reports, and other information used for the compilation of this report were obtained from personnel at the San Luis project site, and from technical personnel at Silver Standard's offices in Lima, Perú, and Vancouver, Canada. REI and RMI assume that those parts of information given verbally and/or in writing by the employees of Silver Standard or Esperanza were essentially complete and correct to the best of each employee's knowledge, and that no information requested was intentionally withheld.

Tonnages stated in this report are dry metric tonnes (dmt). Gold and silver grades are reported in grams per metric tonne. Ounces pertaining to gold and silver metal content are expressed in troy ounces throughout this Technical Report.

All references in this Technical Report to REI's or RMI's "opinion", "belief", "recommendation" or similar phrase specifically are those of Donald F. Earnest, P. Geol., and Michael Lechner, P.Geol., respectively. Both Mr. Earnest (REI) and Mr. Lechner (RMI) as the authors of this Technical Report and in their professional capacities as "Qualified Persons", are independent of both Silver Standard and Esperanza.

The abbreviations that might be used in this report are summarized in Table 2-1 following.

Table 2-1: List of Abbreviations

<u>Abbreviation</u>	<u>Definition</u>	<u>Abbreviation</u>	<u>Definition</u>
μ	micron	km ²	square kilometres
°C	degree Celsius	l	litre
°F	degree Fahrenheit	m	metre
CDN\$	Canadian dollars	m ²	square metres
cm	centimetre	m ³	cubic metres
Dmt	dry metric tonne	amsl	above mean sea level
Dmt	dry metric tonne	mm	millimeter
ft	feet	mph	mile per hour
ft/s	feet per second	oz/ton	ounces per short ton
ft ²	square feet	oz	troy ounce (31.1035 g)
ft ³	cubic feet	oz/t	ounce per metric tonne
g	gram	ppm	part per million
g/t	gram per metric tonne	s	second
hr	hour	t	short ton
ha	hectare	T	metric tonne
in	Inch	Tpa	metric tonne per year
in ²	square inch	Tpd	metric tonne per day
K	kilo (thousand)	US\$	United States dollar
kg	kilogram	wmt	wet metric tonne
km	kilometre	yd ³	cubic yard
%	percent	yr	year

3.0 RELIANCE ON OTHER EXPERTS

RMI and REI have relied on various data and information that were supplied by Silver Standard Resources Inc. in the preparation of this report. That information includes descriptions regarding the property, mineral concessions, permitting, exploration history, geology, mineralization, and descriptions of drilling/sampling methods. The authors have carefully reviewed all of this information and have no reason to believe that any of the data that were supplied are misleading or incorrect. The authors were able to verify that a significant percentage of the assay data were correctly entered into the supplied electronic database. Similarly, the authors reviewed the quality assurance/quality control data that were interpreted by Silver Standard and have deemed that the assays are representative and suitable to be used for estimating mineral resources. The authors also closely followed a geologic interpretation that was prepared by Mr. Ken Konkin in developing an updated block model for the San Luis deposit.

The two authors have also relied on a preliminary metallurgical report that was prepared in February 2008 by F. Wright Consulting, Inc. in discussing the current understanding of possible gold and silver recovery rates.

4.0 PROJECT LOCATION AND DESCRIPTION

4.1 Project Location

The San Luis project is located in the Cordillera Negra of north-central Perú, 513 kilometers north northwest of Lima and 113 kilometers east of the city of Casma (see Figure 4-1), in the political District of Shupluy, Yungay Province, Ancash Department. The property that comprises the project can be found on Peruvian NTS map sheet 19-H, approximately centered at Longitude 77° 47' West and Latitude 9° 23' South, UTM coordinates 8,960,000 m North by 195,000 m East.

Figure 4-1: San Luis Project Location Map
(Excerpted from Figure 6-1, Pincus and McCrea, 2006)

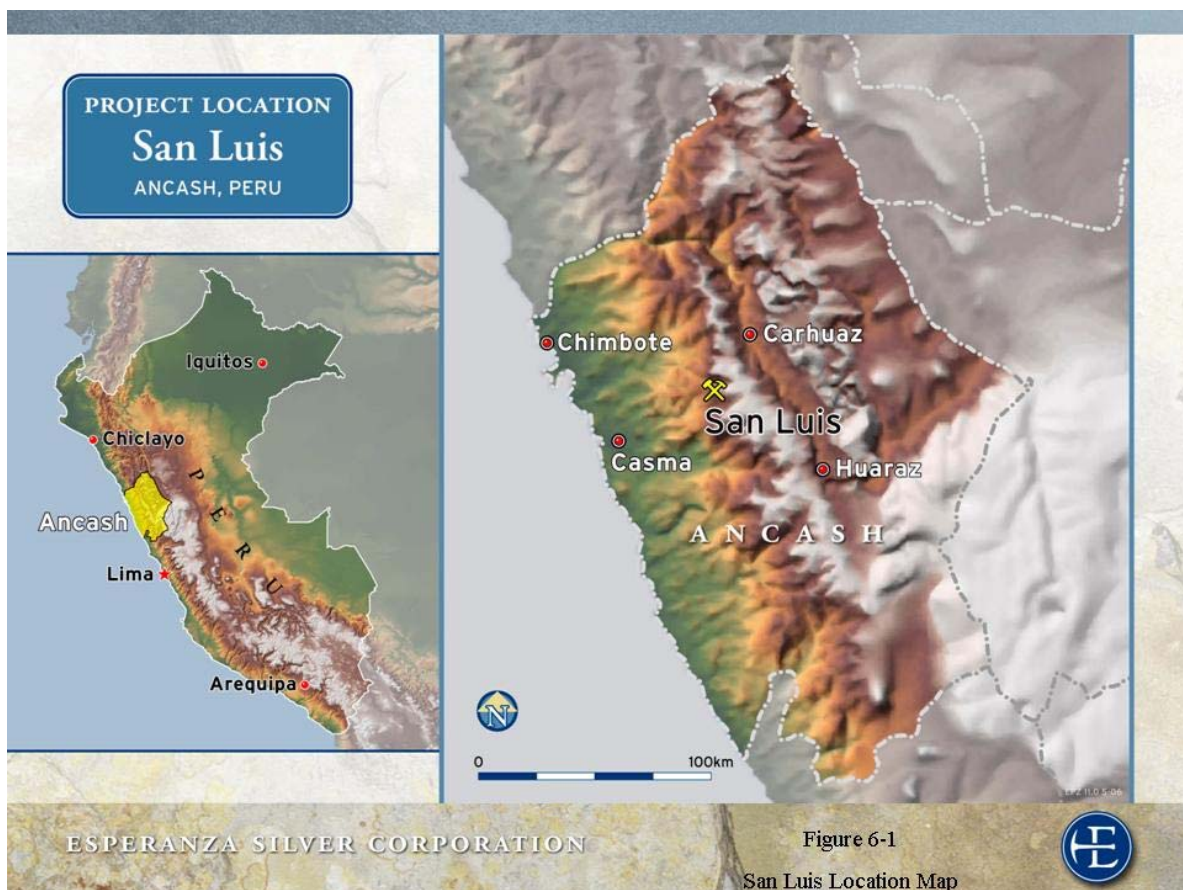

4.2 Project Description

As described in Blanchflower (2007): *“Thirty-four mineral concessions comprise the property, covering an area of 29,338.3326 hectares. All of the mineral concessions are fully titled and contiguous. The configurations and locations of the mineral concessions are shown on Figure 2 of this report and a summary of the mineral concession data is documented in Table 1.”*

“The property has not been legally surveyed. According to Peru’s mining laws, petitions for mining concessions are based on the coordinates of quadrangles and may be up to 1,000 hectares in size, based upon maps provided by the Peruvian National Geographic Institute (1:100,000 scale) with U.T.M. coordinates. Concession boundaries are specified on the application by identifying the locations of the corners of the concessions to the nearest 1,000 m U.T.M. coordinate. All concession boundaries must be oriented north- south and east-west. Concessions awarded prior to 1992 may have irregular coordinates with specific corners that must be legally surveyed and registered with the Ministry of Mlnéz. There are three pre-1992 mineral concessions in the northwestern portion of the property.”

According to Pincus and McCrea (2006): *“In Perú, mining concessions are granted using UTM coordinates to define areas generally ranging from 100 to 1000 hectares. Mining titles are irrevocable and perpetual as long as the titleholder makes payments of annual maintenance fees (Derecho de Vigencia). A titleholder must pay US\$3.00 per hectare per year for each concession acquired. Payments must be made at the time of application for the concession and by June 30 of each subsequent year. The holder must reach a level of sustained annual production equivalent to US\$100 per hectare in gross sales by the end of sixth year from the grant of the concession. If this is not achieved the annual payment increase(s) to US\$9.00 per hectare (US\$3.00 for vigencia plus US\$6.00 as penalty) until the minimum production level is reached. If by the twelfth year the annual production requirement has not been met then the annual payment increases to US\$23.00 per hectare (US\$3.00 for vigencia and US\$20 as penalty). The concession holder can be exonerated from paying the penalty if it can be demonstrated that in the previous year he has invested an amount no less than 10 times the penalty for the entire concession.”*

As stated in Blanchflower (2007): *“In 2005, Peru established a sliding-scale mining royalty. The calculation of the monthly payable royalty is based on the gross metal value of concentrate or metal component when the products are commercialized or alternatively the gross metal value declared by the owner, using international metal prices for evaluating the metal value. Fees, indirect taxes, insurance, transportation costs, warehousing, port fees as well as other costs for exportation and general agreements along international commerce (INCOTERM) may be deducted from the calculation of the royalty. In the case of integrated companies transforming their concentrate, the costs of treatment may also be deducted.”* According to Pincus and McCrea (2006), *“The sliding scale is as follows: first range (1%) – up to US \$60 million annual value; second stage (2%) – from US \$60 to \$120 million; third stage (3%) – in excess of US \$120 million.”*

To the best of REI's and RMI's knowledge, there are no outstanding environmental liabilities regarding the northern portion of the San Luis project that could adversely affect the potential development of the Ayelén and/or Inéz updated Mineral Resources, beyond normal reclamation of exploration drill roads and sites. Figure 7-2 in Section 7.2 of this report shows the San Luis property boundary in red along with the location of the Ayelén and adjacent Inéz veins.

Table 4-1: List of Mineral Concessions

NAME	Hectares granted by INACC	REQUEST DATE	OWNER	TITLE NO.	TITLE DATE	CODE NUMBER	DISTRICT	PROVINCE	DEPARTMENT	YEAR OF PENALTY	ANNUAL COST/UNIT 2007	STATUS
CAHUARAN DOS	882.1297	25-Aug-05	Reliant Ventures	4409-2005	3-Nov-05	01-0265605	SHUPLUY	YUNGAY	ANCASH	2012	\$2,646.39	Titled
CAHUARAN TRES	1,000.0000	25-Aug-05	Reliant Ventures	4534-2005	9-Nov-05	01-0265705	SHUPLUY	YUNGAY	ANCASH	2012	\$3,000.00	Titled
CAHUARAN UNO	1,000.0000	25-Aug-05	Reliant Ventures	4405-2005	3-Nov-05	01-0265805	SHUPLUY	YUNGAY	ANCASH	2012	\$3,000.00	Titled
EPZ CUATRO	699.8284	4-Aug-05	Reliant Ventures	4971-2005	24-Nov-05	01-0245505	SHUPLUY	YUNGAY	ANCASH	2012	\$2,099.49	Titled
EPZ DOS	600.0000	17-May-05	Reliant Ventures	3469-2005	1-Sep-05	01-0120205	PARIACOTO	HUARAZ	ANCASH	2012	\$1,800.00	Titled
EPZ TRES	600.0000	1-Jun-05	Reliant Ventures	3311-2005	15-Aug-05	01-0160305	SHUPLUY	YUNGAY	ANCASH	2012	\$1,800.00	Titled
EPZ UNO	600.0000	17-May-05	Reliant Ventures	3440-2005	31-Aug-05	01-0120305	SHUPLUY	YUNGAY	ANCASH	2012	\$1,800.00	Titled
HUANCHUY	700.0000	24-May-06	Reliant Ventures	4237-2006	12-Oct-06	01-0228106	COCHABAMBA	HUARAZ	ANCASH	2013	\$2,100.00	Titled
LLANAPACCHA DOS	1,000.0000	30-May-06	Reliant Ventures	3560-2006	17-Aug-06	01-0235606	PIRA	HUARAZ	ANCASH	2013	\$3,000.00	Titled
LLANAPACCHA UNO	1,000.0000	30-May-06	Reliant Ventures	3628-2006	25-Aug-06	01-0235506	PIRA	HUARAZ	ANCASH	2013	\$3,000.00	Titled
OCHIAPAMPA DOS	1,000.0000	30-May-06	Reliant Ventures	3553-2006	17-Aug-06	01-02358-06	PARIACOTO	HUARAZ	ANCASH	2013	\$3,000.00	Titled
OCHIAPAMPA UNO	1,000.0000	30-May-06	Reliant Ventures	3645-2006	25-Aug-06	01-02357-06	PARIACOTO	HUARAZ	ANCASH	2013	\$3,000.00	Titled
PUMAHULLCA UNO	500.0000	26-Aug-05	Reliant Ventures	1236-2006	23-Mar-06	01-02779-05	COCHABAMBA / SHUPLUY	HUARAZ / YUNGAY	ANCASH	2012	\$1,500.00	Titled
RAJUJOC OESTE	1,000.0000	30-May-06	Reliant Ventures	3468-2006	15-Aug-06	01-02354-06	PIRA	HUARAZ	ANCASH	2013	\$3,000.00	Titled
SHURAS DOS	1,000.0000	22-Mar-07	Reliant Ventures	0306-2007	14-Aug-07	01-01971-07	COCHABAMBA / CASCAPARA	HUARAZ / YUNGAY	ANCASH	2014	\$3,000.00	Titled
SHURAS TRES	900.0000	20-Apr-07	Reliant Ventures	0709-2007	5-Sep-07	01-02407-07	COCHABAMBA	HUARAZ	ANCASH	2014	\$2,700.00	Titled
SHURAS UNO	1,000.0000	22-Mar-07	Reliant Ventures	0315-2007	9-Aug-07	01-01970-07	COCHABAMBA / SHUPLUY	HUARAZ / YUNGAY	ANCASH	2014	\$3,000.00	Titled
SIEREN DOS	1,000.0000	26-Aug-05	Reliant Ventures	04967-2005	24-Nov-05	01-02785-05	SHUPLUY / CARHUAZ	YUNGAY / CARHUAZ	ANCASH	2012	\$3,000.00	Titled
SIEREN NORTE	992.3955	24-May-06	Reliant Ventures	3690-2006	24-May-06	01-02284-06	SHUPLUY	YUNGAY	ANCASH	2013	\$2,977.19	Titled
SIEREN TRES	700.0000	3-Jan-06	Reliant Ventures	1317-2006	4-Apr-06	01-00014-06	SHUPLUY	YUNGAY	ANCASH	2013	\$2,100.00	Titled
SIEREN UNO	1,000.0000	26-Aug-05	Reliant Ventures	5080-2005	30-Nov-05	01-02782-05	SHUPLUY	YUNGAY	ANCASH	2012	\$3,000.00	Titled
TECLIO DOS	900.0000	30-May-06	Reliant Ventures	3521-2006	16-Aug-06	01-02360-06	CASCAPARA	YUNGAY	ANCASH	2013	\$2,700.00	Titled
TECLIO TRES	663.9790	20-Apr-07	Reliant Ventures	1586-2007	11-Oct-07	01-02408-07	QUILLOCASCAPARA	YUNGAY	ANCASH	2014	\$1,991.94	Titled
TECLIO UNO	600.0000	30-May-06	Reliant Ventures	4326-2006	16-Oct-06	01-02359-06	CASCAPARA	YUNGAY	ANCASH	2013	\$1,800.00	Titled
TOCASH DOS	1,000.0000	26-Aug-05	Reliant Ventures	4717-2005	11-Nov-05	01-02781-05	CARHUAZ	CARHUAZ	ANCASH	2012	\$3,000.00	Titled
TOCASH UNO	1,000.0000	26-Aug-05	Reliant Ventures	4964-2005	24-Nov-05	01-02783-05	CARHUAZ	CARHUAZ	ANCASH	2012	\$3,000.00	Titled
TUNANCANCHA UNO	1,000.0000	20-Apr-07	Reliant Ventures	0895-2007	7-Sep-07	01-02406-07	COCHABAMBA / PARIACOTO	HUARAZ	ANCASH	2014	\$3,000.00	Titled
USHNO DOS	800.0000	26-Aug-05	Reliant Ventures	869-2006	10-Mar-06	01-02780-05	COCHABAMBA / PARIACOTO	HUARAZ	ANCASH	2012	\$2,400.00	Titled
USHNO TRES	600.0000	3-Jan-06	Reliant Ventures	3549-2006	17-Aug-06	01-00015-06	COCHABAMBA	HUARAZ	ANCASH	2013	\$1,800.00	Titled
USHNO UNO	900.0000	26-Aug-05	Reliant Ventures	5077-2005	30-Nov-05	01-02784-05	CARHUAZ	CARHUAZ	ANCASH	2012	\$2,700.00	Titled
YANACOTO CUATRO	700.0000	20-Apr-07	Reliant Ventures	1336-2007	25-Sep-07	01-02410-07	CARHUAZ / SHUPLUY	CARHUAZ / YUNGAY	ANCASH	2014	\$2,100.00	Titled
YANACOTO DOS	1,000.0000	24-May-06	Reliant Ventures	3513-2006	16-Aug-06	01-02283-06	SHUPLUY	YUNGAY	ANCASH	2013	\$3,000.00	Titled
YANACOTO TRES	1,000.0000	24-May-06	Reliant Ventures	3530-2006	17-Aug-06	01-02282-06	SHUPLUY	YUNGAY	ANCASH	2013	\$3,000.00	Titled
YANACOTO UNO	1,000.0000	24-May-06	Reliant Ventures	3570-2006	21-Aug-06	01-02285-06	SHUPLUY	YUNGAY	ANCASH	2013	\$3,000.00	Titled
Total (hectares)	29,338.3326										Total payment	\$88,015.00

5.0 ACCESSIBILITY, CLIMATE, LOCAL RESOURCES, INFRASTRUCTURE AND PHYSIOGRAPHY

5.1 Accessibility

The property that comprises the San Luis project can be accessed via 4-wheel drive vehicles on gravel roads from the city of Carhuaz (58km). The most frequently used route for access to the project is via paved and secondary gravel roads that run from the coastal city of Casma through the towns of Pariacoto and Tambra, a distance of 113 km.

5.2 Climate

As stated in Pincus and McCrea (2006): *“The project area is dry for the greater part of the year, from May to December. During these months the daytime temperature is moderate with a high of 22° Celsius but nights can be as cold as -10° C. The rainy season is from January to April. Temperatures are more moderate but the weather is characterized by sometimes heavy rains, abundant fog, hail and snow at higher elevations. Maximum precipitation is found in February (206 mm) while the driest month is July (2.5 mm).”*

5.3 Local Resources and Infrastructure

The project site is rural and isolated. The nearest population centers are Tambra (located on the western limit of the property) and Pueblo Viejo (situated in the northeast portion of the project concessions). Both villages are located in the Shupluy District, Yungay Province, Ancash Department, and each has approximately 400 inhabitants. The larger population centers near the project are Casma, Carhuaz, and Huaraz. Each of these population centers has available skilled labor and necessary services for exploration and development of a mining project.

5.4 Physiography

As described in Blanchflower (2007): *“The physiography of the region is mountainous with high-elevation rolling hills and valleys surrounding higher craggy snow-capped mountains; typical of the western front of the Peruvian Andes. Relief is high with local elevations varying from 3,600 m (11,811 ft) at the project campsite to 4,850 m (15,912 ft) A.M.S.L. at the peak of Cerro Huilcahuaín.”*

“The local vegetation varies with elevation. Below 4,000 metres elevation there are small deciduous trees and bushes and various grasses while above this elevation the mountain slopes are sparse covered with Stipa lchu (grass) and various small bushes, typical of the ‘Puna’.”

“Domesticated llamas graze the local grasses, and there are several varieties of rodents and resident and migratory birds within the property.”

Although much additional technical work and evaluation must be completed before mining of the updated Ayelén and Inéz Mineral Resources can take place, in the opinion of REI and RMI there appears to be sufficient surface rights for a surface and/or underground mining operation (including waste dumps), a related processing operation (including tailings disposal), and other infrastructure (offices, maintenance shops, etc.).

6.0 HISTORY

As stated in Blanchflower (2007): *“According to Konkin (2007) and Pincus and McCrea (2006), there is no evidence of any modern exploration work or previous land tenure in the vicinity of the San Luis vein system in the west-central portion of the property. Six kilometres to the southeast, there are historic test pits, short adits and evidence of past ‘highgrading’ operations within the BP zone (see Section 8.0 – Mineralization) that were reportedly active in the 1980’s and possibly earlier. It appears that the miners extracted manto-hosted pyrrhotite-sphalerite-galena mineralization and transported the hand-cobbed mineralization away for milling. Nevertheless, it appears that the Ayelén (see Section 8.0 – Mineralization) and the other precious metal-bearing vein structures are grass-root discoveries by the current joint venture partners. There are a number of other precious and base metal occurrences in the region that are owned by other operators. Barrick Gold Corporation owns and operates the Pierina gold mine which is situated approximately 25 km east-southeast of the San Luis property.”*

There are no reported historical mineral resources or documented production from the San Luis property.

7.0 GEOLOGIC SETTING

Much of the following text is either summarized or excerpted from the recent reports by Pincus and McCrea (2006) and Blanchflower (2007).

7.1 Regional Geology

As noted in Blanchflower (2007), *“The Western Andean Cordillera, or Cordillera Negra, is famous for its world-class base- and precious-metal deposits; many of which have been intermittently mined since Incan time. Most of the metal deposits in Peru are spatially and genetically associated with metal-rich hydrothermal fluids generated along magmatic belts that were emplaced along convergent plate tectonic lineaments.”*

“The San Luis property is situated regionally within the Cordillera Negra geomorphological terrane of the Peruvian Andes. A few kilometres east of the property is the northwesterly trending Huaylas Valley, drained by the Rio Santa, and further east is the Cordillera Blanca which includes Cerro Huascarán, the second highest peak in South America at 6,746 m A.M.S.L.”

Stratigraphy

The oldest rocks in the region belong to the upper Jurassic Chicama Formation, which consists of a series of interbedded mudstones and sandstones. The lower Cretaceous Chimú Formation conformably overlies the Chicama formation and is comprised of a sequence of quartzites, sandstones and shales. These rocks often are found in the centers of anticlines outcropping from the western portion of the project area near Pariacoto, extending east of the project area to the Huaylas Valley. Ascending in the regional sequence, the lower Cretaceous Santa Formation (consisting of limestones and calcareous clays) disconformably overlies the Chicama Formation, followed by the Carhuaz Formation (sandstones, quartzites, with interbedded mudstones), and the Farrat Formation (fine quartzites with interbeds of red mudstone), and a Cretaceous sequence of calcareous rocks of the Pariahuanca, Chulec, and Pariatambo Formations, which can be found primarily outcropping on the east flank of the Cordillera Negra.

Overlying the sedimentary Cretaceous sequence in angular unconformity is the volcanic Paleocene Calipuy Formation, which consists of tuffs, coarse pyroclastics, agglomerates, lavas and sub volcanic intrusions. These extrusive rocks are widespread in the Cordillera Negra and are generally andesitic/dacitic to rhyolitic in composition. Overlying the Calipuy Formation is the Mio-Pliocene Yungay Formation, which is composed of dacitic tuffs and ignimbrites. These rocks fill the valley bottoms east of the project area, mainly along the Santa River.

Intrusive rocks in the region consist of the Cretaceous – Paleocene Coastal batholith (found southwest of the project area near Pariacoto) and the Mio – Pliocene Cordillera Blanca batholith. The Coastal batholith is composed of granodiorites and

tonalites that intrude both the Cretaceous formations and the Paleocene Calipuy volcanics. The Cordillera Blanca batholith is also granodioritic to tonalitic in composition. Surficial evidence of these rocks occur in the Cordillera Negra as small outcrops where they intrude into the Calipuy Formation.

Recent surficial deposits in the region are mostly fluvial – glacial in character.

Figure 7-1: Regional Geology
(Excerpted from Figure 4, Blanchflower 2007)

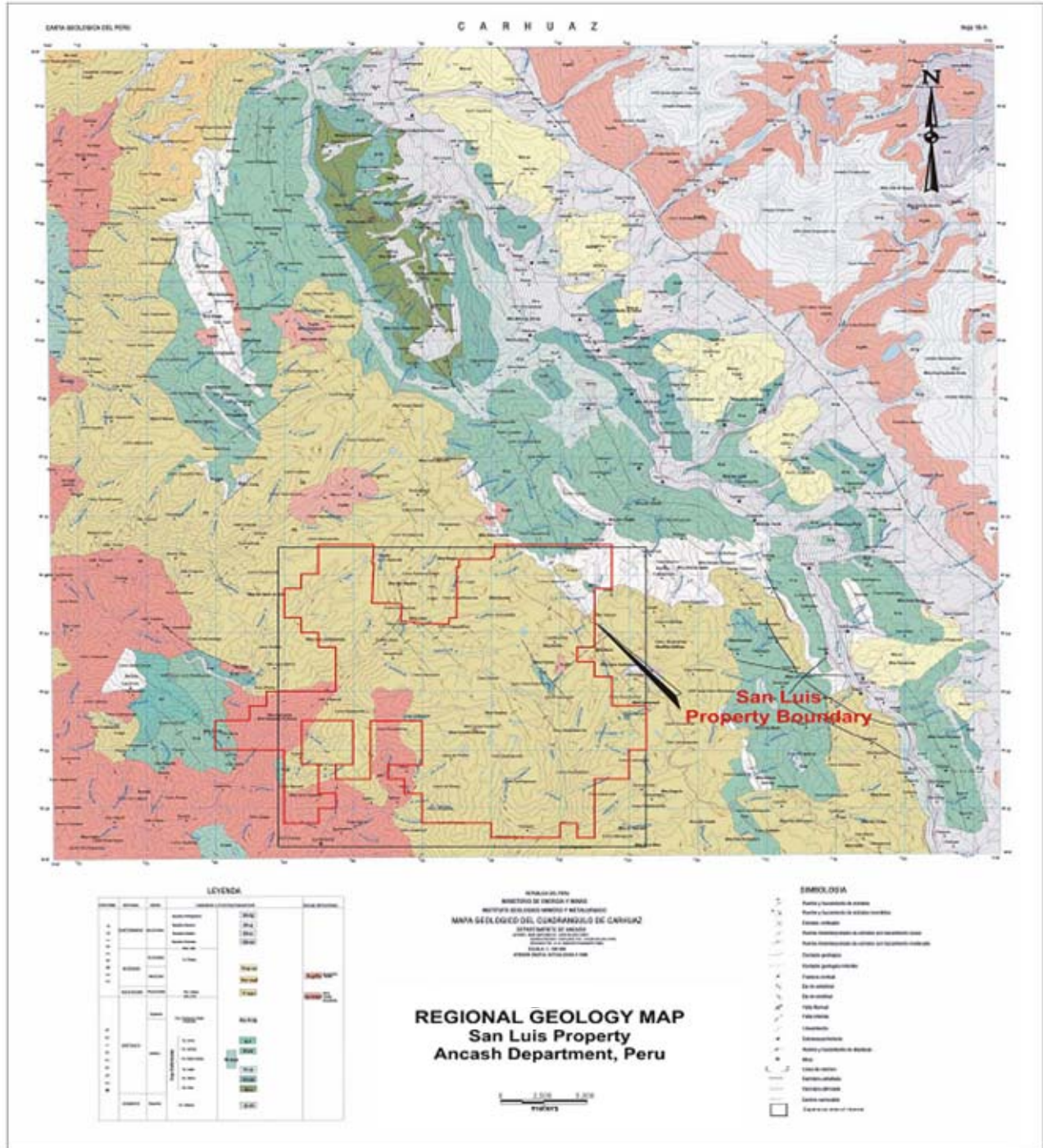

Structure

As described in Pincus and McCrea (2006), “Regionally there is evidence for four stages of structural deformation. The first stage resulted in the lifting of the Andean belt. This was followed by the Andean orogeny characterized by folding and thrust faulting, which affected the Jurassic and Cretaceous sediments. The third stage is distinguished by block faulting resulting in large vertical movements of basement rocks. The final stage of tectonic activity known in the region is a Plio-Pleistocene lifting of the Andean belt. Certain areas such as the Cordillera Blanca, east of the Cordillera Negra have been lifted more than others.”

7.2 Local Geology

Local Stratigraphy

The Paleocene Calipuy Formation is the dominant stratigraphic unit in the San Luis project area, occurring mainly as flat-lying andesite volcanic sediments consisting of interlayered tuffs, coarse pyroclastic flows, volcanic breccias, agglomerates and lava flows. Fine to coarse-grained andesites overlain by beds of interlayered andesite and volcanic breccia that strike northwesterly and dip from sub-horizontal to 30° southwest are the main hosts for the mineralized structures at San Luis.

Small windows in the Calipuy volcanics expose sandstones and fine-grained quartzites interlayered with some claystones of the lower Cretaceous Carhuaz Formation. Other rocks exposed in the project area include granodiorite of the Puscao unit of the Coastal batholith (found along the project’s western boundary near the village of Tambra) and small outcrops of granodiorite and tonalite of the Cordillera Blanca batholith that cut the Calipuy volcanics in the northeastern area of the project. Additional intrusive rocks include a series of rhyolitic sills, dikes, and irregular bodies that occur in intimate association with the San Luis veins. In many cases, these generally tabular intrusives strike roughly parallel to the veins. Figure 7-2 is a general lithology map of the local project area.

The project area also has sporadic fluvial-glacial cover material, with both terminal and lateral moraines identified in isolated areas.

Figure 7-2: Property Geology Map
(Excerpted from Figure 5, Blanchflower 2007)

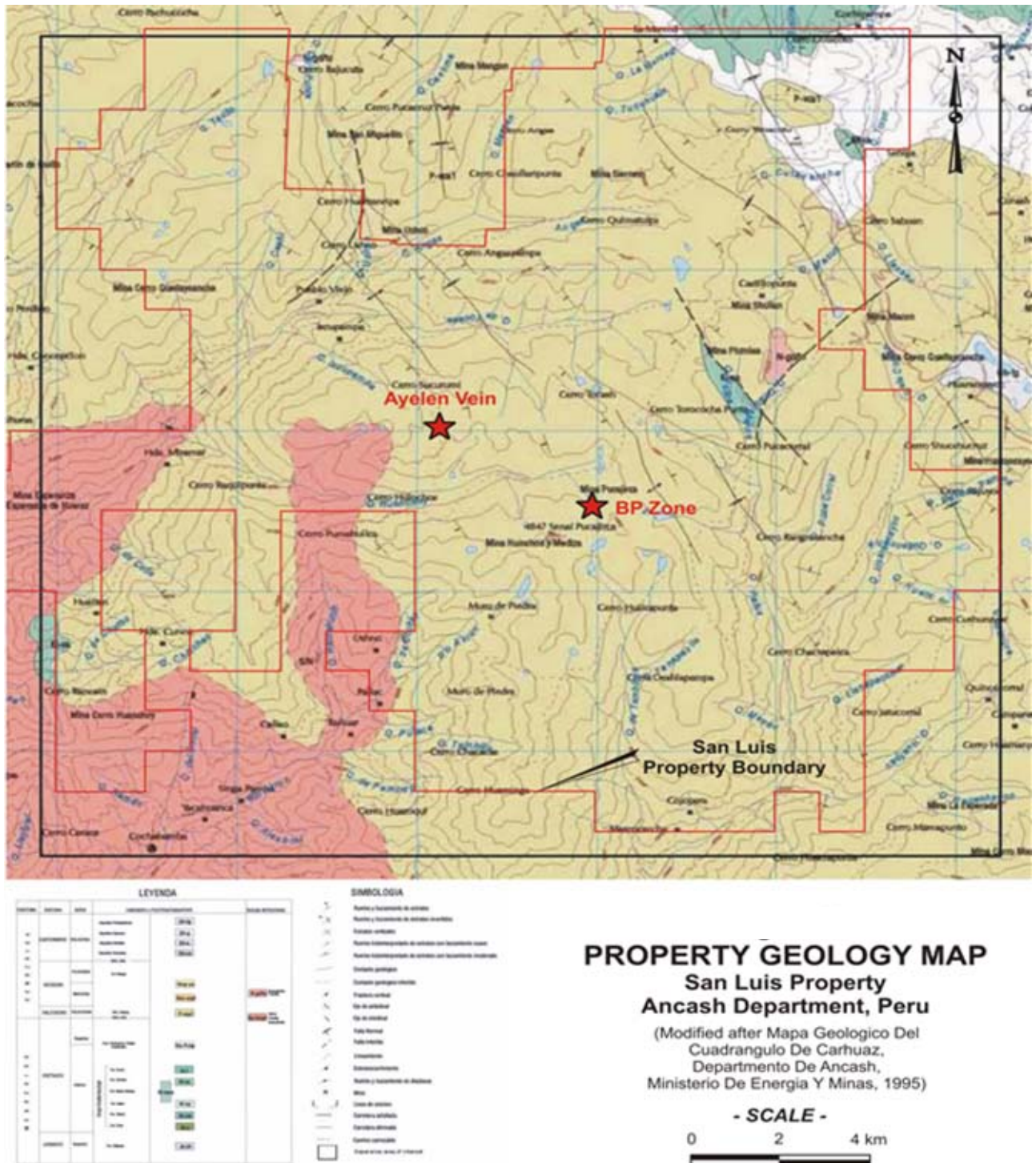

Local Structure

Blanchflower (2007) states: *“Within the property the north-northwesterly trending fault structures are the most important for mineral exploration since they appear to control and host most of the known precious metal-bearing vein structures, such as the Ayelén vein which has been traced on surface for more than 750 m. Other vein structures of the San Luís vein zone occupy similarly oriented fault structures striking northwesterly to north-northwesterly with variable dip angles. The faults hosting the Ayelén and Inéz veins define the western and eastern limits respectively of a horst block that is at least 125 m wide. Here, massive andesite lava rock of the horst is structurally juxtaposed against younger pyroclastic rocks and tuff-breccias to the west and east respectively.”*

“The northwest and north-northwesterly faults, especially those vein-hosting structures, have been repetitively active since the majority of volcanism ceased but prior to the main epithermal veining events. However, faulting also occurred during and after vein emplacement resulting in the well developed vein breccia textures, open tensional sites for later rhyodacitic dyking, and later brecciation and displacement of both the dykes and vein structure.” Pincus and McCreia (2006) note that normal movement (both dextral and sinistral) predominates in the vein structures, with host rock lithologies that include andesite agglomerates underlain by massive andesite flows. Pincus and McCreia (2006) also note that at least three periods of vein emplacement (quartz fissure filling and associated silicification) and a similar number of stages of deformation resulting in both strike and dip/oblique slip features have occurred at San Luis. “Depending on the timing of the mineralization relative to the operative structural regime, ore shoot development would have significantly different orientations (i.e. mineralization during strike slip deformation would tend to have steep raking ore shoots whereas those developed during dip/oblique slip deformation would be much flatter).”

In addition to the veins at the San Luis project, there are a series of breccia bodies related to porphyry-style intrusive bodies approximately 5km south of the Ayelén and Inéz veins (see Figure 7-2). These intrusive bodies are the focus of exploration at the “BP” zone.

Alteration

The volcanic and volcanoclastic rocks of the Calipuy Formation on the property that comprises the San Luis project exhibit widespread propylitic alteration (chlorite alteration of mafic minerals and weak kaolinization of plagioclase), as well as introduction of quartz, calcite, and local magnetite, particularly in well sheared and fractured zones. Blanchflower (2007) notes, *“Iron oxide alteration (gossan) zones are widespread and affect all lithologies, especially the andesitic volcanics at higher elevations of Huilcahuain mountain and surrounding the feldspar porphyry intrusions at Pucajirca summit (Ferraris, 2007).”*

As stated in Blanchflower (2007): *“Konkin (2007) has described the hydrothermal alteration in the vicinity of the Ayelén vein as follows:*

“Although much of the (Ayelén vein) system appears to be near-vertical, the strongest alteration occurs in the hanging wall or western portion of the vein and immediately adjacent to the rhyolitic dykes. The footwall geology is composed primarily of feldspar porphyry flows and its minor associated members. These rocks exhibit weak argillic alteration at the immediate vein and dyke contacts but the alteration rapidly grades to a moderate propylitic alteration just a few centimetres from the structures. Weak to moderate propylitic alteration is commonly observed throughout this entire footwall unit. Very little iron oxidation is associated with the footwall zone.

The strongest alteration occurs throughout the upper half of the hanging wall sequence within the pyroclastic units along shears that host veins and dykes. Strong argillic alteration is observed over 1-2 meter widths within these shear zones. The majority of the pyroclastic upper volcanic sequences contain weak near-surface pervasive argillic alteration. This may be related to the chemical breakdown of the unit rather than the epithermal alteration. Otherwise the majority of the alteration is confined to weak-moderate propylitic alteration similar to that which occurs within the footwall.

Similar to the argillic alteration, strong to moderate limonitic fracture-controlled oxidation is commonly associated with and along the flow-banded rhyolite dyke and veins at the upper portion of the system. The oxide development decreases rapidly below 125-150 meters with only minor sporadic fracture controlled limonite. Due to the low volumetric presence of sulphides, the level of iron oxidation is considered to be low within the Ayelén vein.”

8.0 DEPOSIT TYPE

As described by Pincus and McCrea (2006): *“The San Luis vein system has many of the characteristics of “low to intermediate-sulphidation” or “quartz-adularia” epithermal, precious metal deposit(s).” “Low sulphidation mineralization consists of a gangue mineral assemblage containing quartz-calcite-adularia-illite. Gold typically occurs as electrum and silver occurs as electrum, acanthite and other silver sulphosalts. Epithermal deposits are characterized by a variety of textures including crustiform banding, often with interlayers of quartz and sulfide minerals. Bands are often interrupted indicating repeated pulses of mineralization. Lattice textures in which calcite crystals have been replaced by quartz and brecciation are also common characteristics.”*

“Interpretations of the epithermal model indicate that ore-bearing fluids typically travel along structural pathways at high temperatures with sufficient hydrostatic pressure to prevent boiling. When the pressure drops suddenly through faulting or rupture, boiling occurs and the fluids quickly deposit their mineral load in available open spaces. Deposition of minerals, particularly quartz will typically occur in these open spaces with bands growing from either wall inward. Open spaces are eventually sealed by this growth until ruptured once again by underlying fluid pressure or new faulting and the process begins over again. This repeated rupturing results in the interrupted banded texture typical of epithermal veins.”

“Structural features, particularly faulting and fracturing, are a key element in controlling the location of ore deposition. Ore “shoots” will typically occur in dilational zones, which in turn result from a variety of local stresses. Often these stresses are repeated along the length of a vein structure resulting in multiple ore-shoots.”

9.0 MINERALIZATION

The major veins identified to date are the Ayelén, Inéz, Paula, Regina, and Sheyla. These veins outcrop in a northwest-trending fault-fracture zone (see Figure 9-1). The veins are manifested on the surface in a series of linear outcrops with thicknesses that range up to 20 meters wide. The veins, taken together, have a cumulative strike length of almost 5000 meters.

The quartz veins (which are hosted by the andesites of the Calipuy Formation) contain high-grade gold and silver mineralization consisting of electrum, acanthite and other silver sulphosalts. Gangue minerals present in the veins are principally quartz and adularia, although in some areas calcite blades that have been replaced by silica have their original crystal structures preserved. Banding, typical of epithermal deposits, is common (see Figure 9-2). This often shows interruption of bands indicative of repeated pulses of mineralization.

The mineralization on which the Mineral Resource update that is the subject of this Technical Report was based is contained in the Ayelén and Inéz veins (see Figure 9-3), which are described in greater detail in the following sections:

Figure 9-1: Satellite View of the Major Veins of the San Luis Project
(Excerpted from Photograph 9, Blanchflower 2007)

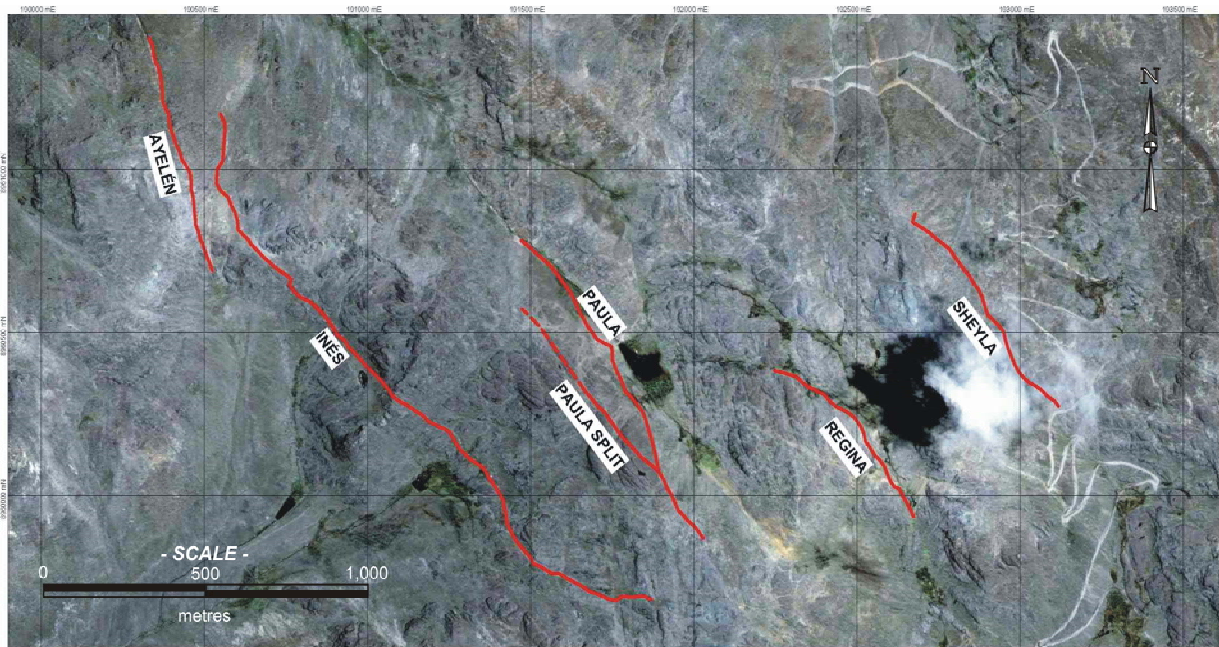

Figure 9-2: Multi-Stage Quartz Banding
(Excerpted from Photograph 10, Blanchflower 2007)



9.1 Ayelén Vein

As described in Blanchflower (2007): *“The Ayelén vein is the most extensively explored and better mineralized of the known vein structures. Trenching and diamond drilling have traced this structure along a strike length of over 720 m with down dip extensions of 100 to 327 m, striking of 340° to 345°. Surface mapping results indicate that the vein structure dips -75° to -85° west-southwesterly, but drilling results show that the controlling fault structure(s), sub-surface individual vein segments and post-mineral dykes dip vertically to -80° west-southwesterly. True thicknesses of individual vein segments vary from 10’s of centimetres to over 10 metres, averaging 1.5 to 3 m wide.”*

“Thirty-two surface trenches were excavated along the surface trace of the Ayelén vein and 108 diamond drill holes, totaling 19,195.15 m, have tested its down dip extensions during the 2006 and 2007 exploration programs. The results of this work show that the vein structure has been displaced by faulting and shearing repeatedly during the emplacement of the veining, mineralization and later dyking. The mineralizing events appear to have extended from the initial vein emplacement to after the emplacement of the two varieties of felsic dykes since, although generally barren, the dykes do host very local fracture filling precious and base metal mineralization. Repetitive faulting and shearing has produced multiple lenticular vein bodies or segments that dominantly occur on the footwall or east-northeasterly side of the dykes in the southern portion of the structure but occur between and bound the dykes on both sides towards the north-northwestern end.

Thus, the collective Ayelén vein structure has been subdivided into hangingwall and footwall sections based upon their relative position with respect to the post-mineral dykes.”

”Vein composition, texture and mineralogy are characteristically epithermal, low sulphidation vein type. Quartz, chalcedony, calcite and minor adularia are the main gangue minerals, occurring with typical banding, layering and brecciation. Electrum, acanthite and other silver sulphosalts are the main economic minerals accompanied by trace amounts of sulphide minerals including: pyrite, chalcocopyrite, galena and sphalerite.”

Figure 9-3: Geologic Plan Map of Ayelén and Inés Veins
(Excerpted from Figure 6, Blanchflower 2007)

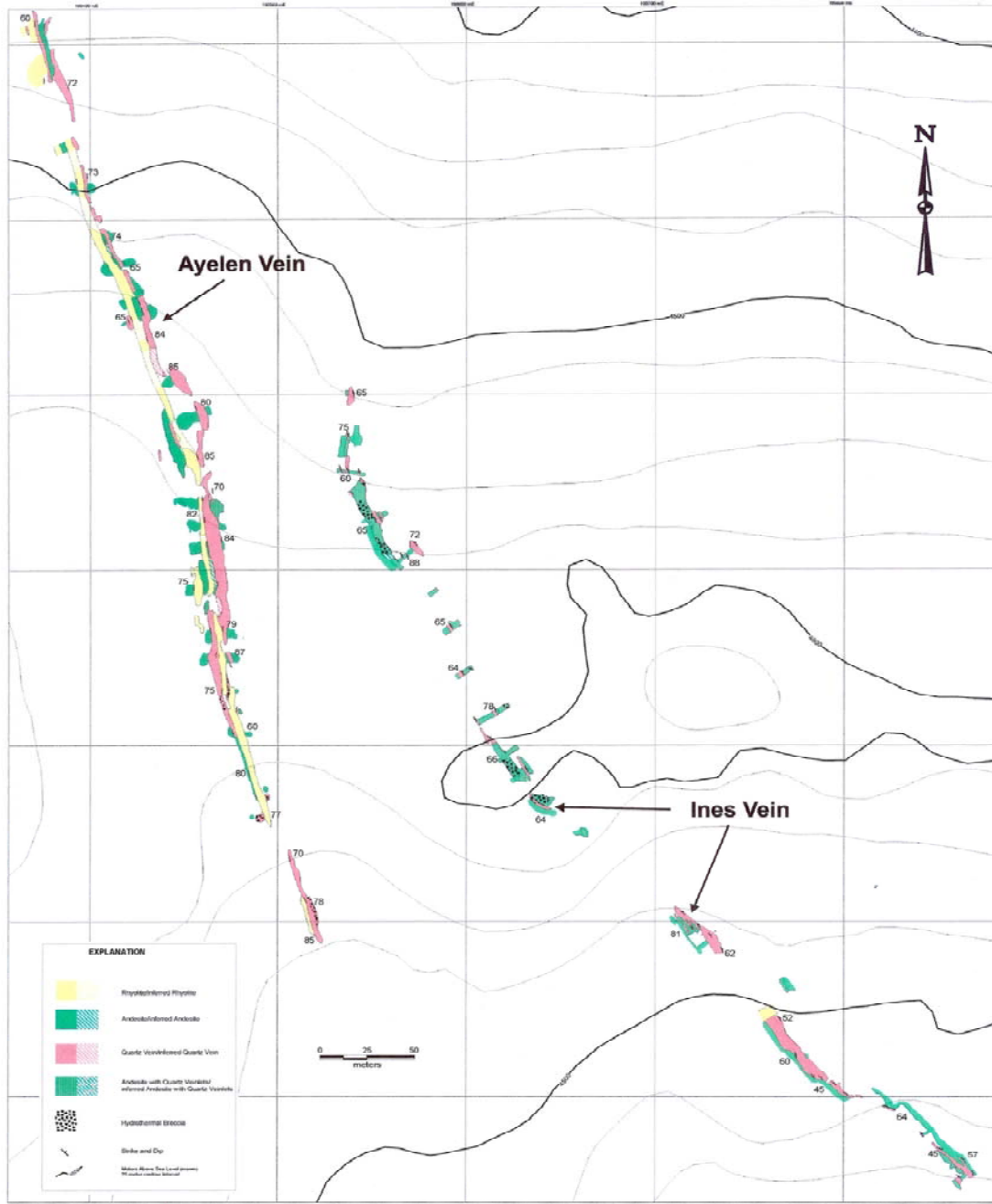

9.2 Inéz Vein

The Inéz vein (often referred to as “Ines”) is situated approximately 110 m east of the Ayelén vein, striking northwesterly at 320° to 340° and dipping -50° to -75° northeastwardly (see Figure 9-3). As noted in Blanchflower (2007): *“Drilling and geomodeling results indicate that the primary normal easterly dipping, fault structure controlling this vein may intersect the Ayelén vein structure in the vicinity of surface trench number 16 at U.T.M. 190455 m east by 8961000 m north with parasitic structures trending northward. The main brittle-ductile structure appears to be a listric fault, since the vein is dips about -75° eastwardly near surface then progressively more gently at -60° to -45° as it is traced downwards. The Inés vein crops out as series of discontinuous resistant ridges for more than 2,200 m along strike with apparent widths of 2 to 7.5 m, but assay results from the outcrop and surface trench samples show that only a relatively short section of the Inés vein is significantly mineralized with gold and silver. This mineralized section is situated where it is closest to the Ayelén vein.”*

10.0 EXPLORATION

No exploration work took place on the Ayelén and Inéz veins in 2008 since completion of the last NI 43-101 Technical Report on the San Luis Project (Blanchflower – 2007). During 2008, exploration work at San Luis focused on porphyry-style occurrences at what is known as the BP zone (see Figure 7-2). Since examination/evaluation of the BP zone exploration activity was not part of the scope of work for this update of the Mineral Resources in the Ayelén and Inéz veins, no summary of the 2008 exploration work completed on the BP zone is included in this technical report.

For the sake of completeness in this Technical Report, the following subsections briefly summarize the exploration work completed on the Ayelén and Inéz veins from 2005 through 2007. Thorough descriptions of this work can be found in earlier NI 43-101 Technical Reports authored by Pincus and McCrea (2006) and Blanchflower (2007).

10.1 2005 Exploration Program

As summarized by Blanchflower (2007): *“The San Luis property was first visited by Esperanza field personnel in June 2005. They discovered and sampled the Inés vein structure which returned values ranging from trace to 1.56 gpT gold and 0.8 to 100 gpT silver. During a later property visit in July 2005 the Ayelén and Paula vein structures were discovered, prospected and channel sampled. The channel samples from the Ayelén vein returned values ranging from 0.026 to 173.8 gpT gold and 23 to 2,504 gpT silver (Pincus and McCrea, 2006).*

Prospecting work by Esperanza later in the year led to the discovery of the nearby Sheyla and Regina vein structures.”

10.2 2006 Exploration Program

As summarized in Blanchflower (2007): *“Dr. Eric P. Nelson was retained to carry out geological mapping and a detailed structural analysis of the area surrounding the San Luis vein system at a scale of 1:2 000.” “Systematic channel sampling of the Ayelén and Inés vein structures was initiated in January 2006 and completed by November after being delayed during the rainy season. According to Pincus and McCrea (2006), thirty-two separate trenches were excavated along the trend of the Ayelén vein structure at 25-metre intervals and 403 channel samples were collected along these trenches from the vein structure and wall rock.” (see Figure 10-1). “True thicknesses of the samples were calculated using the vein dips at each sample site. These vein dip angles varied from -70° to -85° west-southwestwardly. The results of the channel sampling showed that the Ayelén vein structure hosted values ranging from trace to 134 gpT gold and 5.3 to 2,246 gpT silver over true vein thicknesses of 0.98 to 7.14 m (Pincus and McCrea, 2006).” (See Figure 10-2 of this Technical Report) for the locations of channel sample results along the central portion of the Ayelén vein).*

“Twenty-five trenches were excavated across the Inés vein structure at 25-metre intervals and 90 channel samples were collected along these trenches from the vein structure and wall rock. Vein structure dip angles varied from -65° to -75° northeastwardly from which true thicknesses of the structure were calculated. Pincus and McCrea (2006) reported precious metal values for samples that graded greater than 1 gpT gold or represented longer true widths across the Inés vein structure. The reported results ranged from trace to 21.07 gpT gold and trace to 1969 gpT silver across true widths of 0.66 to 3.43 m.”

“The results of this work identified the high gold and silver grades hosted by the Ayelén and Inés vein structures and showed that these veins have features commonly associated with typical low sulphidation epithermal vein systems. A detailed description of the trenching and rock geochemical sampling work is documented in the technical report by Pincus and McCrea (2006).”

Figure 10-1: Trench with Spray-Painted Locations of Individual Channel Samples
(Excerpted from Photo 17 – Blanchflower, 2007)



Figure 10-2: Locations of 2006 Channel Samples on Central Portion of Ayelén Vein
(Excerpted from Figure 7, Blanchflower (2007) & Pincus and McCrea (2006))

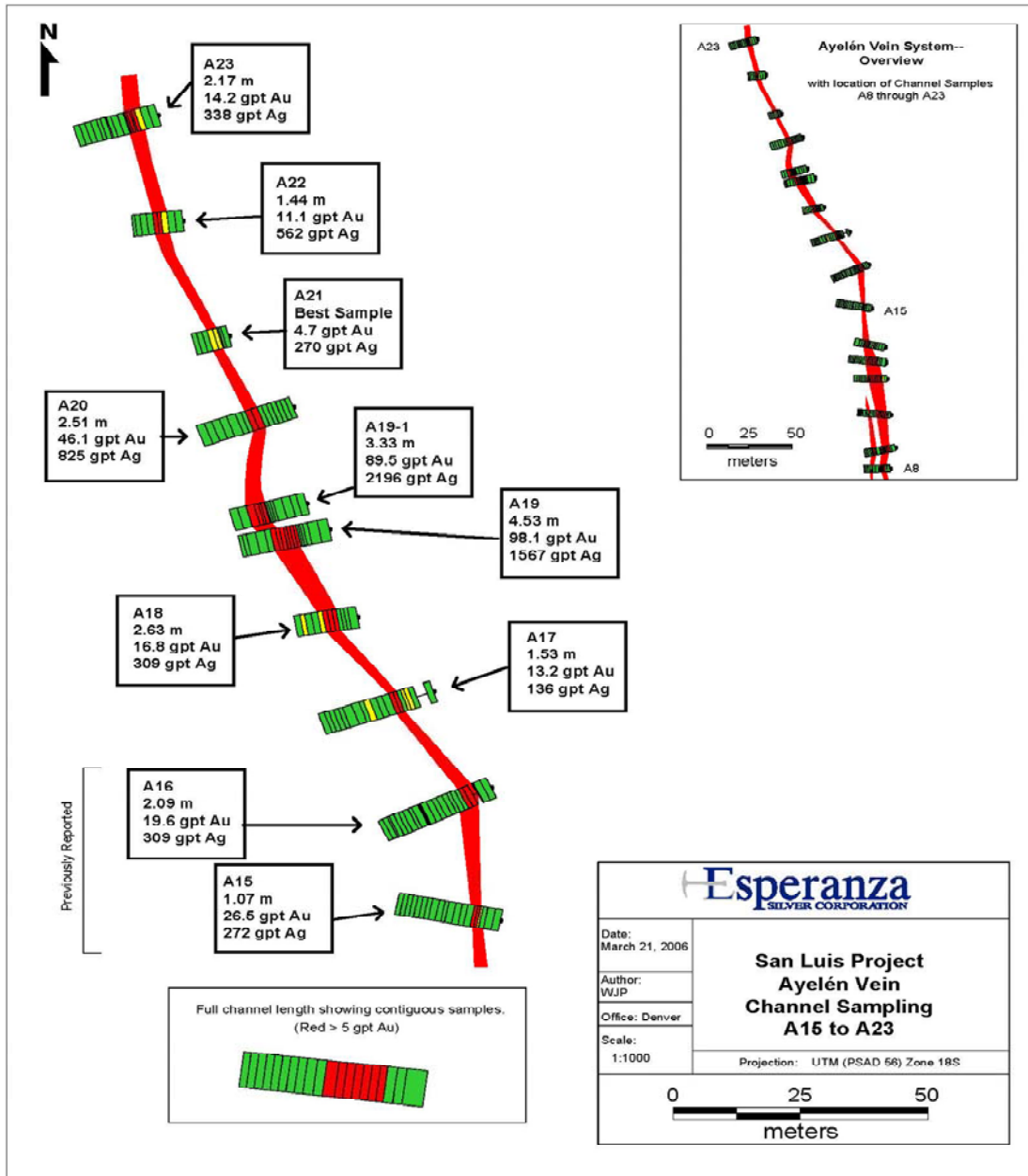

On September 25, 2006, Esperanza commenced the first drilling program on the San Luis property. It was initially proposed for a minimum of 4,000 m of HQ-size diamond drilling to evaluate the higher grade sections of the Ayelén and Inéz vein structures as well as other vein-hosted targets on the property. At the time of the Pincus and McCrea technical report (November 22, 2006), twelve drill holes had been completed, totaling 1,500 m, and the drill core assay results from the first four drill holes were reported.

During 2006 Esperanza and later the Esperanza-Silver Standard joint venture completed 28 HQ-size diamond drill holes, totaling 3,764.9 m, to test the down dip extensions of the Ayelén and Inéz veins.

10.3 2007 Exploration Program

Much of the 2007 exploration program was devoted to evaluation of the portion of the property around the BP zone. This work included surface geologic mapping, silt (soil) geochemical sampling, rock geochemical sampling, and geophysical surveying (ground magnetics and induced polarization). This work is not summarized here, but is covered in detail in Blanchflower (2007).

As described in Blanchflower (2007): *“During the latter half of 2006, Silver Standard and Esperanza formed their current joint venture and continued their exploration efforts through their joint venture subsidiary company, Reliant Ventures S.A.C., under the terms of their agreement.”*

“In 2007 Reliant Ventures continued drill testing of the Ayelén and Inés vein structures and proceeded to drill test the other known San Luis vein systems, including: Paula, Paula Split, Regina, Sheyla and Puca-Puca. Near the end of the field season four drill holes tested coincident geological, geophysical and geochemical anomalies in the vicinity of the mineralized hydrothermal breccia situated centrally within the BP zone. A total of 133 HQ-size diamond drill holes were completed during the 2007 field season totalling 23,261.05m.”

A summary of the exploration work pertaining to the low-sulphidation veins including the Ayelén and Inéz structures is provided in Blanchflower (2007), as follows:

- *“The property hosts three known types of mineralization: precious metal-bearing epithermal veins, manto-hosted base metal occurrences and hydrothermal breccia-hosted base metal occurrences;”*
- *“The San Luis vein system, including the Ayelén, Inés, Paula, Paula Split, Regina, Sheyla and Puca-Puca veins, has been initially tested by prospecting, rock geochemical sampling, trenching and diamond drilling. The cumulative strike length of the combined vein structures is almost 5 km and less than one-quarter of this strike length has been explored;”*
- *“Property-wide stream sediment sampling results show a number of geochemical anomalies worthy of follow-prospecting and rock geochemical sampling;*
- *There is a 400- to 500-metre section of the Ayelén vein and a 100 to 150-metre section of the Inés vein, near the Ayelén vein, with significant economic potential worthy of continued work.”*

11.0 DRILLING

During its visit to the San Luis project site in June 2008, REI was told that all diamond drilling of the Ayelén and Inéz veins was performed by Boart Longyear ('Longyear') of Lima, Perú, using LF-70 and LY-44 rigs. All holes were reportedly collared with HQ-size drilling tools that recovered 63.5 mm-diameter core, with reductions to NQ-size tools (47-6 mm-diameter core) if poor drilling conditions were encountered.

Drill hole collar sites reportedly were first surveyed using GPS instrumentation and subsequently using Distamat surveying equipment. Upon completion, all drill hole locations were immediately surveyed, and surveyors marked the location of the collars of the drilled holes with labelled rock cairns.

Drill holes were surveyed down-hole using an Easyslot® survey tool that collected azimuth and inclination data at regular 50-meter intervals down-hole, with the final shot taken near the bottom of each drill hole. All down-hole survey data were recorded on the field geologic logs and subsequently in the electronic drill hole database.

During its June 2008 site visit for the purpose of this Technical Report, REI examined Ayelén vein intercepts from ten diamond core holes, including A-SL-087, A-SL-082, A-SL-079, A-SL-064, A-SL-069, A-SL-104, SL07-001, SL-07-002, SL06-01, and SL06-04. In all cases, the core was found to be in excellent condition and order, with clearly labeled run blocks in place and sample breaks clearly noted. In the holes examined the core was well-sawn (see Section 12.0 – Sampling Method and Approach).

11.1 Diamond Core Data

Logging of diamond drill core included the recording of lithologic, structural, alteration and mineralogical features observed by the project geologists onto conventional logging forms. These data were then transcribed onto drill hole-specific spreadsheet-type files that could be imported directly into a Gemcom® database. In REI's opinion, the logging of lithologies was very detailed and well done, with numerous (over 50) individual lithologic designations. Structure, alteration and mineralization logging was generally well done. The logging of geotechnical data was not extensive, with only core recovery (%), rock quality designation (RQD), and a general description of core quality recorded. Core quality designations included "muy bueno" (very good), "bueno" (good), "regular" (fair), "malo" (bad), or "muy malo" (very bad).

For the purpose of this report, only diamond core holes that tested the Ayelén and Inéz veins were used. The San Luis Joint Venture has drilled other holes in the district but those data were not reviewed by the authors. Table 11-1 summarizes the number of diamond core holes and total meterage by area that were used for this report. Only about 20 percent of the total drilled meterage shown in Table 10-1 was assayed.

Table 11-1: Summary of Diamond Drill Hole Data

Area	Number	Meters
Ayelén	108	19,196.15
Inéz	28	3,157.80
Total	136	22,353.95

The majority of the core holes were drilled steeply (-45 to -85 degrees) to the northeast as shown in Table 11-2, which breaks the drilling data down by orientation.

Table 11-2: Diamond Drill Hole Orientations

Drill Hole Orientation	Number	Meters
Vertical Downward Hole	4	525.10
Steep Downward Northeasterly Angle Hole	14	2,490.00
Steep Downward Easterly Angle Hole	72	12,482.75
Steep Downward Southerly Angle Hole	2	176.50
Steep Downward Southwesterly Angle Hole	17	2,276.50
Steep Downward Westerly Angle Hole	26	4,308.10
Shallow Downward Easterly Angle Hole	1	95.00
Total	136	22,353.95

In addition to the diamond core holes, a series of chip-channel samples were collected from trenches that were located at approximately 25-meter-spaced intervals along the strike length of the outcropping Ayelén and Inéz veins. The trench data were treated like sub-horizontal drill holes for constructing vein wireframes and estimating Mineral Resources. Table 11-3 summarizes the number of trenches and total meterage by area. Most of the trench samples were assayed.

Figure 11-1 is a plan map that shows the areal extent of the surface drilling and trench sampling data that were used to prepare the resource estimate that is the subject of this report. The plan map distinguishes between surface diamond core holes and surface trenches. The main Ayelén and Inéz wireframes are also shown along with the lines of section that were used to construct the geologic interpretation.

Figure 11-1: Drill Hole Plan Map

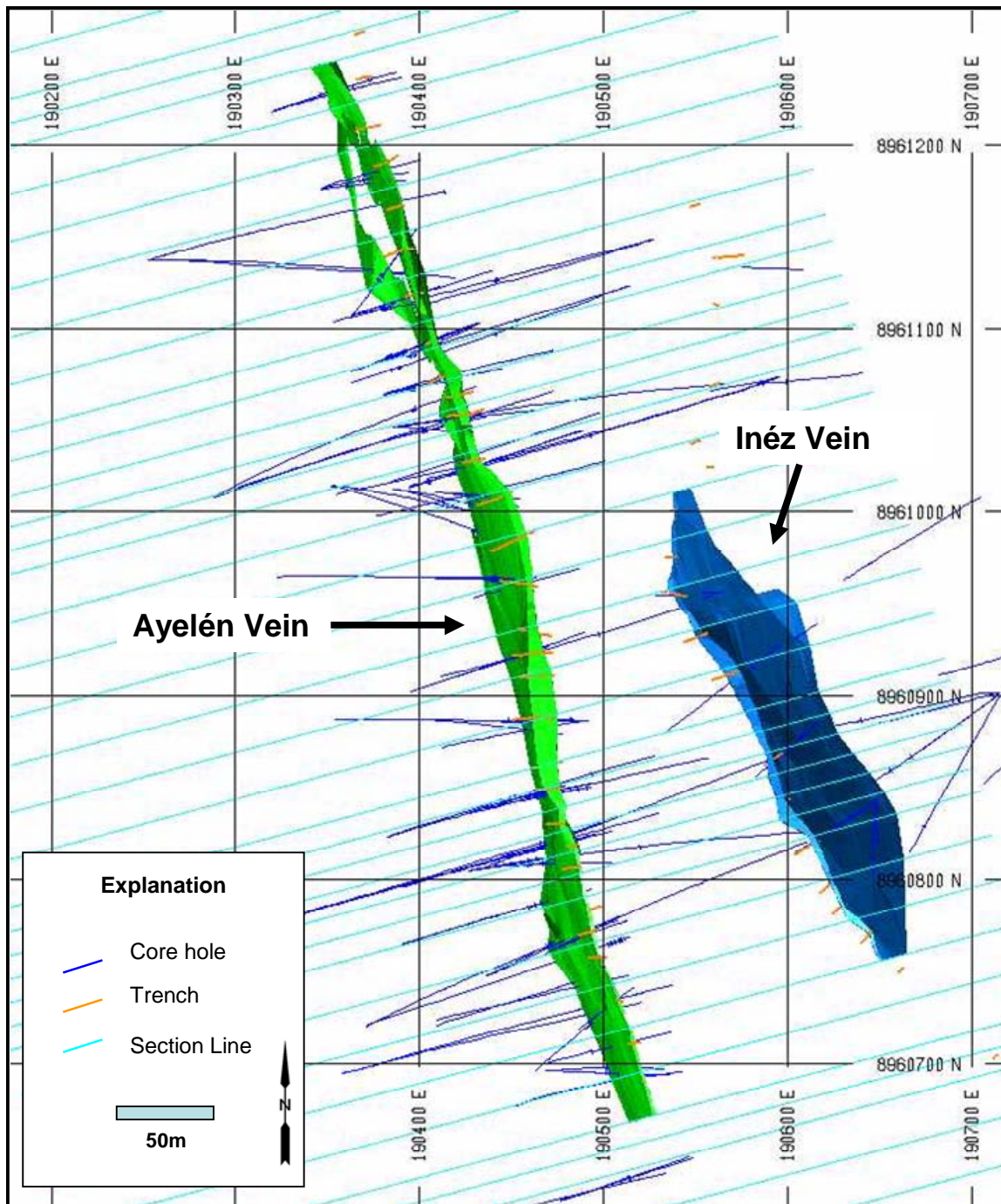

Table 11-3: Summary of Chip-Channel Trenches

Area	Number	Meters
Ayelén	34	506.21
Inéz	62	441.00
Total	96	947.21

11.2 Results of the Drilling Programs

As described in Blanchflower (2007), “Drilling results for the central portion of the Ayelén vein structure show that structure is comprised of multiple lenticular vein segments resulting from repetitive faulting and shearing during the emplacement of the epithermal quartz veining, auriferous mineralization and later rhyolitic and felsic dyking. The vein structure has been traced on surface for 720 m and down dip for 100 to 327 m along a strike orientation of 340° to 345°. Within its known strike length there is a central 400- to 500-metre long section that appears to have been better mineralized with longer drill intercepts. On surface the vein structure dips -75° to -85° west-southwesterly but drilling results show that the controlling fault structure(s), sub-surface individual vein segments and post-mineral dykes dip sub-vertically to -80° west-southwesterly. True thicknesses of individual vein segments vary from 10’s of centimetres to over 10 metres, averaging 1.5 to 3 m wide.

Multiple lenticular vein segments dominantly occur on the footwall or east-northeasterly side of the dykes in the southern portion of the Ayelén vein structure but occur between and bound the dykes on both sides towards the north-northwestern end. Thus, the collective Ayelén vein structure has been subdivided into hangingwall and footwall sections based upon their relative position with respect to the dyking. The mineralogical and textural features of the various vein segments vary with depth, probably due to vertical zonation during their original epithermal emplacement.

The highest gold and silver grades commonly occur within 100 metres of topographic surface but may extend to vertical depths of 200 metres or more. Very fine-grained pyrite, native gold, native silver, electrum, acanthite, sphalerite, chalcopyrite, galena and possible tetrahedrite occur in paragenetically late quartz + sericite ± calcite veinlets and breccias-fillings.

The Inés vein has been traced on surface for over 2,200 m, trending northwesterly at 320° to 340°.” “The better mineralized section of the Inés vein is where it is in close proximity to the Ayelén vein and where it has sizeable epithermal quartz lodes. Otherwise, it has the appearance of a brittle-ductile fault zone, approximately 1 to 5 m wide, hosting anastomosing veinlets of quartz and tectonic breccias healed by quartz and coarse-grained calcite. The results of 28 diamond drill holes along a 475-metre long section of the Inés vein structure indicate that only a short section, perhaps 100 m in strike length, is host to potentially economic gold-silver mineralization.”

11.3 Sample Length Versus True Thickness

Approximately 96 percent of the diamond core samples were collected with lengths ranging between 0.5 and 1.5 meters. A significant number of the core holes were sampled at exactly one-meter-lengths and was a deciding factor in choosing a composite length for estimating Mineral Resources (Section 17.7). Approximately 71% of the chip-channel samples were collected with lengths ranging between 0.5 and 1.5 meters.

Most of the diamond core holes were drilled at steep angles to the east resulting in obtuse intersection angles with the steep west dipping vein. The surface chip-channel samples were oriented perpendicular to the strike length of the Ayelén and Inéz veins and closely represent the true thickness of the veins at the sampled locations. The true thickness of the veins range between ten's of centimeters to over 10 meters and average between 1.5 to 3.0 meters in width. The veins appear to be thicker near the surface and become thinner and lower grade with depth.

11.4 Orientation of Mineralization

The majority of the mineralization is hosted in the Ayelén vein, which strikes between N20°W and N15°W and dips steeply to the west ranging between 75 to over 85 degrees. Several sub-parallel hangingwall and footwall veins associated with the main Ayelén vein have similar steep dips to the west. The main Ayelén and associated splays are seen to become vertical and locally dip steeply to the east. One exception is a mineralized structure that was interpreted by Ken Konkin which intersects the main Ayelén vein and dips at about 40-45 degrees to the east (MZONE 13).

The Inéz vein also strikes northwesterly (N40°W to N20°W) but dips between 45 to 75 degrees to the east. Most of the diamond core holes that have sampled the Inéz vein were drilled westerly in order to intersect the east dipping vein at near right angles.

12.0 SAMPLING METHOD AND APPROACH

In REI's opinion, the trench and drill hole samples collected in the methods described hereafter were representative and were generally absent of recovery issues that could materially bias or otherwise affect the subsequent updated Mineral Resource estimate that is the subject of this Technical Report.

12.1 Description of Sampling Methods

The project geologists who logged the core also determined the core intervals to be sampled. Sample intervals averaged approximately 1.0 meter in length, with individual samples rarely greater than 1.5 meters or less than 0.5 meters in length. Definite breaks were made at geologic contacts (vein/wallrock boundaries, lithologic contacts). Within an individual geologic unit sample intervals were extended or reduced to allow for a nearby geologic contact. The maximum allowable sample length was 2.0 meters.

Once the project geologists marked the sample interval breaks, core from each assigned sample interval was individually removed and cut in half lengthwise using a diamond saw. After sawing, one-half of the drill core was placed in a 6-mil plastic sample bag and the other half was returned to its original position in the core box. In the core from ten holes examined by REI during the June 2008 site visit, all core was found to be well-sawn, with the remaining half core carefully placed in the boxes in good order.

Once sampling was complete, the individual core sample bags were then securely tied with non-slip plastic straps, properly labeled and stored in a locked room in the core storage facility under the supervision of the project geologist until they could be shipped to the assay laboratory.

12.2 Drilling and Sampling Factors

Diamond core recovery for the various drill campaigns was excellent. Fifty-six percent of the assayed intervals had a core recovery of 100% and 95 percent of the data had core recoveries in excess of 90%.

For the minor amount of drilling where core recovery was below 50%, gold and silver grades tended to be lower than the grades in intervals having higher recovery.. Metal grades were relatively constant once recovery in excess of 90% was achieved, ranging between 0.90 to 1.2 g/t gold and 34 to 43 g/t silver for all assayed intervals (including those outside of the mineralized wireframes).

12.3 Core vs. Chip-Channel Sample Quality

The majority of the data that were used to estimate Mineral Resources were derived from HQ diamond drill holes (73%) and the remainder obtained from chip-channel samples collected from "trenches" spaced along the outcropping veins. RMI reviewed the two data

types because of an apparent disparity between the mean grades of the two sampling methods when all data are compared. The trench samples have a much higher mean grade than the diamond core holes. The reason for this apparent bias is that nearly all of the trench samples were collected from the mineralized vein while a significant portion of the angle drill holes sampled barren hangingwall and footwall waste lithologies.

All of the Ayelén trench samples were spatially paired with the closest HQ drill hole samples so that various statistics could be calculated. Both sample types were composited after the raw assay data were capped at 130 g/t and 3800 g/t for gold and silver, respectively. Note that a final gold capping limit of 2400 g/t was used for the estimate of Mineral Resources. There were a total of 145 Ayelén trench composites that were paired with the core holes. Table 12-1 compares the spatially paired core and trench sample grades.

The data in Table 12-1 show that the gold and silver core samples are about 10 percent higher than the chip-channel samples. This is a much different relationship than a simple comparison of the mean grades for each sample as shown in Tables 17-4 and 17-8 for gold and silver, respectively. Those tables suggest that the trench samples are significantly higher than the core samples.

Quantile-Quantile (QQ) plots were generated from the data shown in Table 12-1 to show the comparison between the two sample types for the 145 paired data. Figure 12-1 and Figure 12-2 show the comparison for gold and silver for the paired data, respectively.

Table 12-1: Paired Core vs. Chip-Channel Sample Grades

Sample Type	No. Composites	No. Meters	Gold Grades (g/t)			Std. Dev.	CV	GT
			Min	Mean	Max			
Chip Channel	145	145.5	0.03	23.03	130.00	34.12	1.48	3,350
HQ Core	145	145.5	0.00	25.75	130.00	35.10	1.36	3,746
% Difference	0%	0%	n/a	-11%	0%	-3%	9%	-11%

Sample Type	No. Composites	No. Meters	Silver Grades (g/t)			Std. Dev.	CV	GT
			Min	Mean	Max			
Chip Channel	145	145.5	2.00	564.9	3800.0	839.9	1.49	82,161
HQ Core	145	145.5	1.00	621.2	3800.0	816.1	1.31	90,351
% Difference	0%	0%	n/a	-9%	0%	3%	14%	-9%

Figure 12-1: Ayelén Au QQ Plot – Core vs. Chip Channel

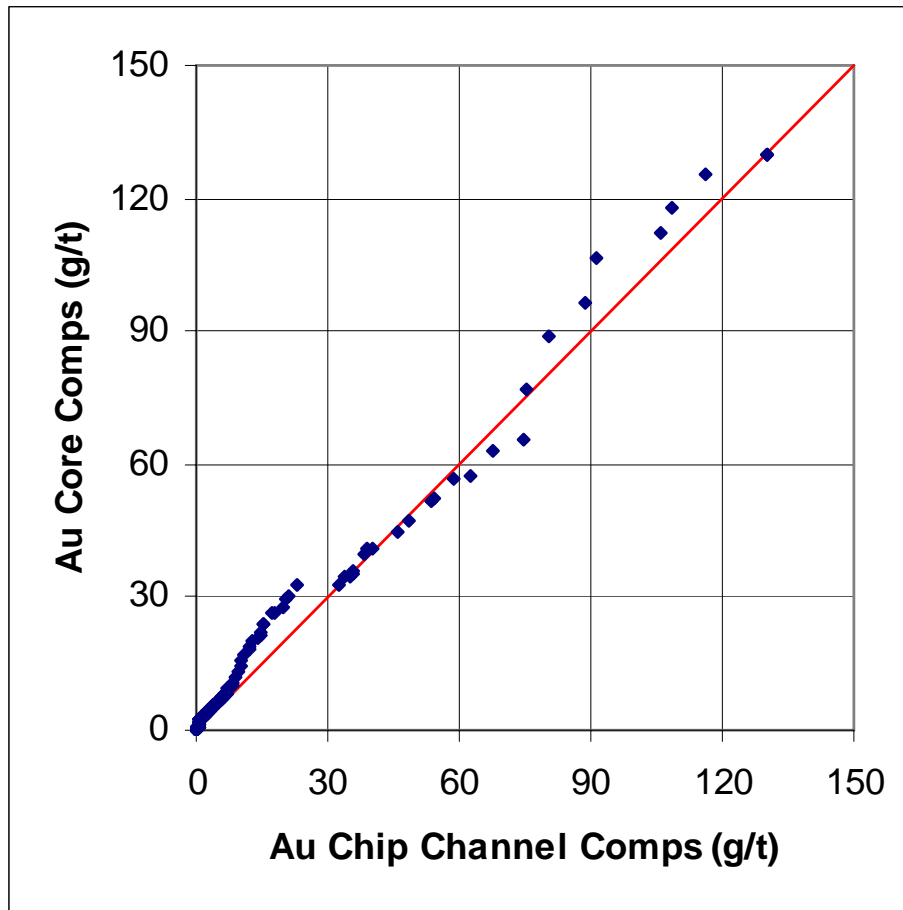
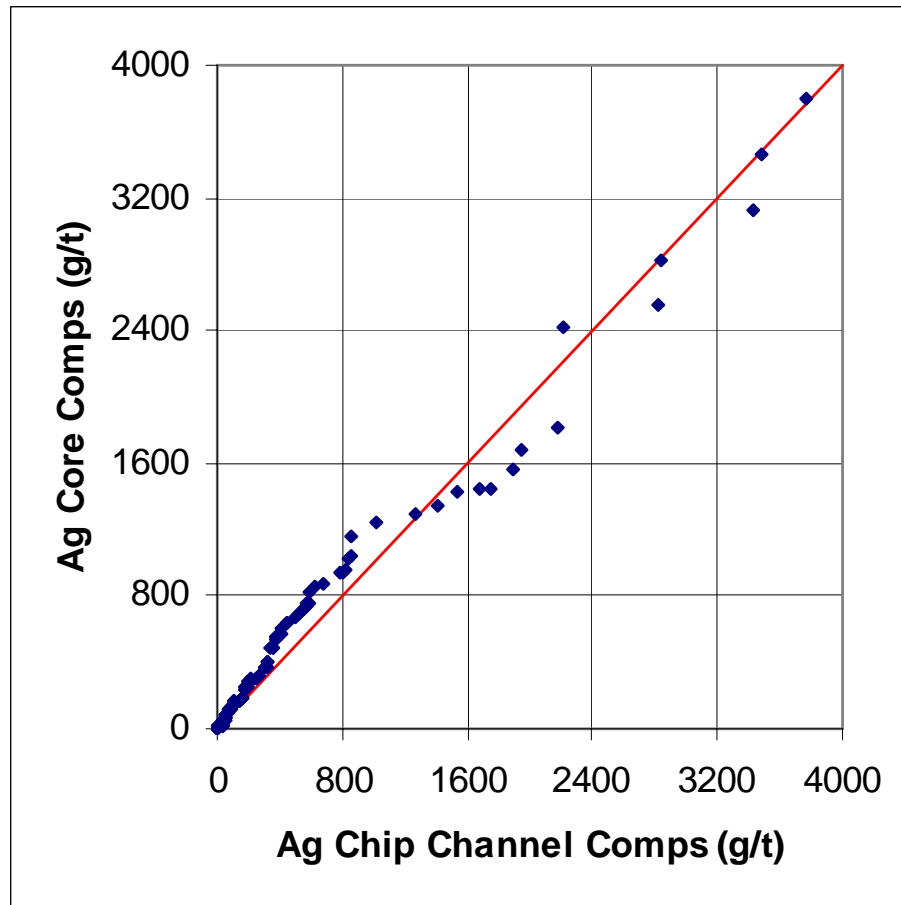

Figure 12-2: Ayelén Ag QQ Plot – Core vs. Chip Channel



Based on the paired statistical comparisons between diamond core and chip-channel composites, RMI believes that the sample data are representative and suitable to be used to estimate Mineral Resources.

12.4 Geologic Controls – High-grade Zones

Two zones of high-grade mineralization were detected during a review of the assay data. These zones outcrop along the Ayelén vein and extend down-dip approximately 60 meters. The two zones were modeled using a 130 g/t gold cutoff grade (see Section 17.9) and were used in the grade estimation plan (see Section 17.11). These two zones form lenses of higher-grade mineralization within well mineralized vein material.

12.5 Summary of Relevant Samples

A list of significantly mineralized composites that were used to estimate Mineral Resources is shown in Table 12-1. These samples represent 50 of the highest grade samples. The gold equivalent (AuEQV) grades were calculated using a gold to silver ratio of 65:1. The table gives the drill hole or trench name, lengths, metal grades (based on capped gold and silver assays), and mineral zone (MZONE) codes. It is important to note that the true widths of individual drill hole vein intercepts are taken into account in the construction of the three-dimensional vein solids for modeling prior to estimation of Mineral Resources (see Section 17-

Table 12-2: Relevant Compositated Samples

Drill Hole/Trench	From Depth (m)	To Depth (m)	Length (m)	Au (g/t)	Ag (g/t)	AuEQV (g/t)	Sample Type	MZONE
A-SL-001	129.10	130.10	1.00	76.66	2050.2	108.20	HQ Core	10
A-SL-001	130.10	131.10	1.00	120.96	2400.0	157.88	HQ Core	10
A-SL-060	115.30	115.45	0.15	54.30	2400.0	91.22	HQ Core	15
A-SL-098	73.65	74.65	1.00	79.05	969.6	93.96	HQ Core	10
A-SL-098	74.65	75.65	1.00	118.07	1497.1	141.10	HQ Core	10
A-SL-098	75.65	76.65	1.00	114.10	1436.2	136.20	HQ Core	10
A-SL-098	76.65	77.65	1.00	99.45	1238.5	118.50	HQ Core	10
A-SL-098	77.65	78.65	1.00	88.97	1167.7	106.93	HQ Core	10
A-SL-126	130.20	131.20	1.00	111.72	2276.8	146.75	HQ Core	10
A-SL-126	131.20	132.20	1.00	95.38	1902.2	124.65	HQ Core	10
A-SL-126	132.20	133.20	1.00	97.20	1928.4	126.87	HQ Core	10
A-SL-127	146.50	147.50	1.00	80.38	1532.7	103.96	HQ Core	10
A-SL-127	147.50	148.50	1.00	52.82	2016.4	83.84	HQ Core	10
SL06-01	48.00	49.00	1.00	62.77	1298.5	82.74	HQ Core	10
SL06-01	49.00	50.00	1.00	65.29	1444.7	87.51	HQ Core	10
SL06-01	50.00	51.00	1.00	57.35	1681.0	83.21	HQ Core	10
SL06-09	38.72	39.72	1.00	130.00	2400.0	166.92	HQ Core	10
SL06-09	39.72	40.72	1.00	130.00	2400.0	166.92	HQ Core	10
SL06-09	40.72	41.72	1.00	111.93	2067.1	143.73	HQ Core	10
SL06-10	62.30	63.30	1.00	130.00	2400.0	166.92	HQ Core	10
SL06-10	63.30	64.30	1.00	127.39	2394.2	164.22	HQ Core	10
SL06-10	64.30	65.30	1.00	106.47	2347.8	142.59	HQ Core	10
SL06-10	65.30	66.30	1.00	96.45	1955.7	126.53	HQ Core	10
SL06-13	89.40	90.40	1.00	61.08	1819.3	89.06	HQ Core	10
SL06-16	44.90	45.90	1.00	130.00	2400.0	166.92	HQ Core	10
SL06-16	45.90	46.90	1.00	77.06	1509.5	100.29	HQ Core	10
SL06-17	52.60	53.60	1.00	130.00	2400.0	166.92	HQ Core	10
SL06-17	53.60	54.60	1.00	125.17	2400.0	162.09	HQ Core	10
SL06-25	119.77	120.77	1.00	58.26	1523.0	81.69	HQ Core	10
A10	4.16	5.16	1.00	88.93	1659.0	114.45	Trench	10
A10	5.16	6.16	1.00	130.00	2400.0	166.92	Trench	10
A10	6.16	7.16	1.00	130.00	2400.0	166.92	Trench	10
A11	6.00	7.00	1.00	65.56	2022.0	96.67	Trench	10
A11	7.00	8.00	1.00	106.18	2400.0	143.10	Trench	10
A11	8.00	9.00	1.00	126.66	2393.0	163.47	Trench	10
A11	9.00	10.00	1.00	91.26	1529.1	114.79	Trench	10
A12	10.25	11.25	1.00	67.35	829.7	80.12	Trench	10
A19	11.11	12.11	1.00	74.52	825.0	87.21	Trench	10
A19	12.11	13.11	1.00	108.54	1795.1	136.16	Trench	10
A19	13.11	14.11	1.00	58.64	1413.0	80.38	Trench	10
A19	14.11	15.11	1.00	90.11	1410.2	111.81	Trench	10
A19	15.11	16.11	1.00	116.27	1884.7	145.27	Trench	10
A19	16.11	17.11	1.00	130.00	2235.0	164.38	Trench	10
A19	17.11	17.80	0.69	130.00	1954.0	160.06	Trench	10
A19-1	8.88	9.88	1.00	62.32	1641.5	87.57	Trench	10
A19-1	9.88	10.88	1.00	106.96	2400.0	143.89	Trench	10
A19-1	10.88	11.88	1.00	130.00	2400.0	166.92	Trench	10
A19-1	11.88	12.88	1.00	77.43	1427.6	99.39	Trench	10
A20	8.97	9.85	0.88	75.27	1273.0	94.85	Trench	10
A9	3.50	4.50	1.00	80.47	2400.0	117.39	Trench	10

13.0 SAMPLE PREPARATION, ANALYSES AND SECURITY

As described in Blanchflower (2007): *“During the 2006 exploration program sample preparation and analyses were carried out by SGS del Perú S.A.C. laboratories in Lima, Peru. SGS is accredited to the ISO/IEC 172025 standard which is specifically designed for Mineral Analysis Testing Laboratories. A complete description of the 2006 channel sample and initial drill core sample preparation and analyses is contained in the report by Pincus and McCrea (2006).”*

Reliant Ventures utilized the assay laboratories of ALS Chemex Peru S.A. in Lima to prepare and analyzed the 2007 drill core samples. ALS Chemex is an internationally recognized minerals testing laboratory, and accredited to the ISO/IEC 172025 standard.”

13.1 Sample Preparation Procedures

Blanchflower (2007) describes sample preparation procedures as follows: *“Upon arrival at the ALS Chemex laboratory the drill core samples were logged into their system. Each sample was placed into a stainless steel tray and dried for approximately 4 to 8 hours, depending upon its moisture content. Then each sample was progressively crushed by primary and secondary crushers until more than 70% of the crushed sample passed through a 2 mm (Tyler 10 mesh) screen. Standard crushing practices also included repeatedly cleaning the crusher prior to, during and after each sample batch using coarse quartz material, and air cleaning the crushers after each sample. The sample material was then riffle split to obtain approximately 250 to 500 grams and the remaining coarse reject material was returned to Reliant Ventures for storage in their Lima warehouse for possible future use.*

The 250 to 500 gram sample, size dependent upon requested analyses, was pulverized using a disk pulverizer until 85% of the pulverized material passed through a 75 micron (Tyler 200 mesh) screen. Then 250 grams of finely pulverized material was transferred to a paper envelope for later analytical work. This same preparation procedure was used for both rock chip and drill core samples.”

In REI’s opinion, the sample preparation procedures as described in Blanchflower (2007) and Pincus and McCrea (2006) are appropriate for the type of epithermal gold-silver mineralization present in the San Luis deposit.

13.2 Sample Analytical Procedures

According to Blanchflower (2007): *“All of the drill core samples were initially analyzed for 35 elements using conventional ICP-AES analysis (ALS Chemex Procedure ME-ICP61a and 62). This analytical procedure uses a mixture of nitric, perchloric and hydrofluoric acids to digest the sample pulp. Elements are determined by inductively coupled plasma and atomic emission spectroscopy (‘ICP-AES’). The determined elements are: Al, Ca, Fe, K, Mg, Na, S, Ti, As, B, Ba, Be, Bi, Cd, Co, Cr, Cu, Ga, La, Mn, Mo, Nb, Ni,*

P, Pb, Sb, Sc, Sn, Sr, Tl, V, W, Y, Zn and Zr. A summary of the lower and upper detection limits for each of these elements accompanies the ALS Chemex procedures document in Appendix II of this report.

Given the significant to high gold and silver grades hosted by the Ayelén and Inés vein structures special care was taken analysing all drill core samples for their precious metal values. The most common used initial procedures for gold analysis were a combination of fire assay fusion with atomic absorption spectroscopy analysis (ALS Chemex Procedures Au-AA23 (30 g), -24 (50 g), -25 (30 g) and -26 (50 g)). The difference between Au-AA23 versus -24 and Au-AA25 versus 26 is the weight of the sample used for analysis while the difference between Au-AA23 and 24 versus Au-AA25 and 26 is that the former two procedures have 0.005 and 10 ppm as their lower and upper detection limits versus 0.01 and 100 ppm for the latter two procedures. Regardless, all four procedures involve the fusion of a metal bead that is then digested in acids, cooled, diluted and analyzed by atomic absorption spectroscopy versus matrix-matched standards. When the analytical result exceeded 10 ppm gold a re-analysis was requested using a second method (Au-GRA21) which is a fire assay of a 30-gram charge with a gravimetric finish.

Two procedures were utilized for the silver analyses. The initial procedure was the digestion of a 0.25-gram sample and its analysis using inductively coupled plasma and atomic emission spectroscopy ('ICP-AES'). The lower and upper detection limits of this method are 1 and 100 ppm. When any analytical results exceeded 100 ppm silver, a 30-gram sample charge was re-analyzed using a fire assay fusion and gravimetric analysis finish procedure (Ag-GRA21) which has lower and upper detection limits of 5 and 10,000 ppm respectively."

In REI's opinion, the sample analytical procedures as described in Blanchflower (2007) are appropriate for the type and tenor of epithermal gold-silver mineralization present in the San Luis deposit.

13.3 Sample Security and Chain of Custody Procedures

Once sampling was complete, the individual 6-mil sample bags containing the core samples were then securely tied with non-slip plastic straps, properly labeled and stored in a locked room in the core shed under the supervision of the project geologist until they could be shipped to the assay laboratory. Prior to shipping, the individual sacks of samples were placed into large woven nylon "rice" bags, their contents were marked on each bag, and each bag was securely sealed. These "rice" bags containing the individual samples were then delivered directly to the ALS Chemex assay laboratory in Lima, Perú by Reliant Ventures personnel, maintaining an uninterrupted chain of custody between the drill rigs and the assay laboratory.

No aspects of the sample preparation or sample analysis were conducted by an employee, officer, director, or associate of either Silver Standard Resources Inc. or Esperanza Silver Corporation, to the best knowledge of either REI or RMI.

14.0 DATA VERIFICATION

As described in Blanchflower (2007): *“The Reliant Ventures, on behalf of the Esperanza-Silver Standard joint venture, has established a rigorous quality assurance (‘QA’) program utilizing quality control (‘QC’) samples to monitor accuracy (i.e. sample standards), contamination (i.e. sample blanks), precision (i.e. duplicates) and other possible sampling errors (i.e. sample mis-labelling). Sample results are monitored by Reliance and Silver Standard personnel for any quality control failures or problems. Should any occur, they are reported to the assay laboratory and check analyses are performed to rectify the failure.*

The QA-QC protocol utilized on the project required the insertion of quality control samples at a rate of approximately seven percent (7%) or one sample per 15 samples submitted to the assay laboratory. Check assaying at a secondary laboratory were carried out at the rate of five percent (5%). Thus, a quality control sample was inserted randomly within every 15 consecutive samples, alternating between standard, blank or duplicate samples. The standard and blank samples were inserted into the sample sequence as the sample shipment was being readied while any duplicate samples were inserted into the sample sequence at the time of collection. The quality control samples were numbered in the same way as the primary samples and were not identified in any other manner.”

In REI’s opinion, the QA/QC procedures described in Blanchflower (2007) were adequate for monitoring sampling and sample preparation/analysis of the drill core samples.

14.1 Electronic Database Verification

RMI obtained copies of signed assay certificates for 31 core holes and/or trenches as summarized in Table 14-1. A representative number of sampling campaigns were selected for verification. The certified assays were compared against the provided electronic database to verify its accuracy.

Table 14-1: Verified Data

Data	No. Checked	No. Errors	Description
A10	34	0	Ayelén Trench
A11	44	0	Ayelén Trench
A12	36	0	Ayelén Trench
A13	40	0	Ayelén Trench
A14	30	0	Ayelén Trench
A15	40	0	Ayelén Trench
A16	50	6	Ayelén Trench
A17	38	0	Ayelén Trench
A18	24	0	Ayelén Trench
A19	36	0	Ayelén Trench
A-SL-001	214	0	Ayelén Core Hole
A-SL-016	14	0	Ayelén Core Hole
A-SL-030	76	0	Ayelén Core Hole
A-SL-053	50	0	Ayelén Core Hole
A-SL-057	16	0	Ayelén Core Hole
A-SL-069	68	0	Ayelén Core Hole
A-SL-075	92	0	Ayelén Core Hole
A-SL-087	94	0	Ayelén Core Hole
A-SL-098	32	0	Ayelén Core Hole
A-SL-112	78	0	Ayelén Core Hole
A-SL-126	84	0	Ayelén Core Hole
I10	30	0	Inéz Trench
I13	12	0	Inéz Trench
I-SL-004	54	0	Inéz Core Hole
I-SL-017	90	0	Inéz Core Hole
I-SL-037	16	0	Inéz Core Hole
I-SL-096	42	0	Inéz Core Hole
SL06-01	142	0	Inéz Core Hole
SL06-10	66	0	Inéz Core Hole
SL06-25	106	0	Inéz Core Hole
SL06-28	84	0	Inéz Core Hole
Grand Total	1832	6	n/a

Only three gold and three silver data errors were discovered for Ayelén trench A16. It appears that the records were shifted downward one row in the electronic database. These errors were corrected prior to estimating Mineral Resources. Table 14-2 summarizes the results of the database review.

Table 14-2: Database Verification Results

Data Type	Total No. Records	No. Records Checked	% of Records Checked	Errors Found	% Error Rate
Au Assays	5,353	916	17%	3	0.33%
Ag Assays	5,353	916	17%	3	0.33%
Total	10,706	1,832	17%	6	0.33%

In RMI's opinion, the San Luis assay database is within industry accepted tolerances for accuracy (typically less than 1% errors) and is sufficiently accurate to be used to estimate Mineral Resources.

14.2 Review of QA/QC Results

The authors have reviewed various QA/QC reports that pertain to the assay data which are relative to this report and were subsequently used to estimate Mineral Resources (McCrea, 2006), (McCrea, 2007), (Blanchflower, 2007). Mr. McCrea made several recommendations including:

- Complete checking of QA/QC results and re-running trays with failed samples
- Complete a revised round robin assaying campaign of standard reference (SRM) materials
- Checking the QA/QC SRM results using 2 standard deviations
- Checking for lab contamination during sample preparation
- Increasing the size of the pulp bags supplied to the lab to eliminate "not sufficient sample" size errors

The authors agree with the above recommendations by Mr. McCrea and suggest the following additional points:

- Increase the frequency of blank sample submission from 1 in 50 to 1 in 20
- Obtain a higher grade silver standard reference for future assaying

RMI independently reviewed the results from 138 quarter core duplicate samples that were obtained from the 2006 and 2007 drilling campaigns. Table 14-3 summarizes the basic descriptive statistics for these duplicate samples.

Table 14-3: Quarter Core Duplicate Sample Statistics

Statistical Parameter	Gold		Silver	
	Original	Duplicate	Original	Duplicate
Count	138	138	138	138
Minimum (g/t)	0.003	0.003	0.40	0.40
Maximum (g/t)	122.620	148.700	3793.00	4335.00
Mean (g/t)	2.327	2.834	78.83	89.52
Median (g/t)	0.026	0.024	1.15	1.20
Mode (g/t)	0.003	0.003	1.00	1.00
Standard Deviation	12.292	15.043	382.80	441.13
Coefficient of Variation	5.28	5.31	4.86	4.93

The duplicate quarter core samples came back with higher average grades for both gold and silver although this comparison is based on a limited number of samples. Figure 14-1 contains various graphical comparisons between the original and duplicate gold quarter core samples.

Figure 14-1: Quarter Core Duplicate Sample Results – Gold

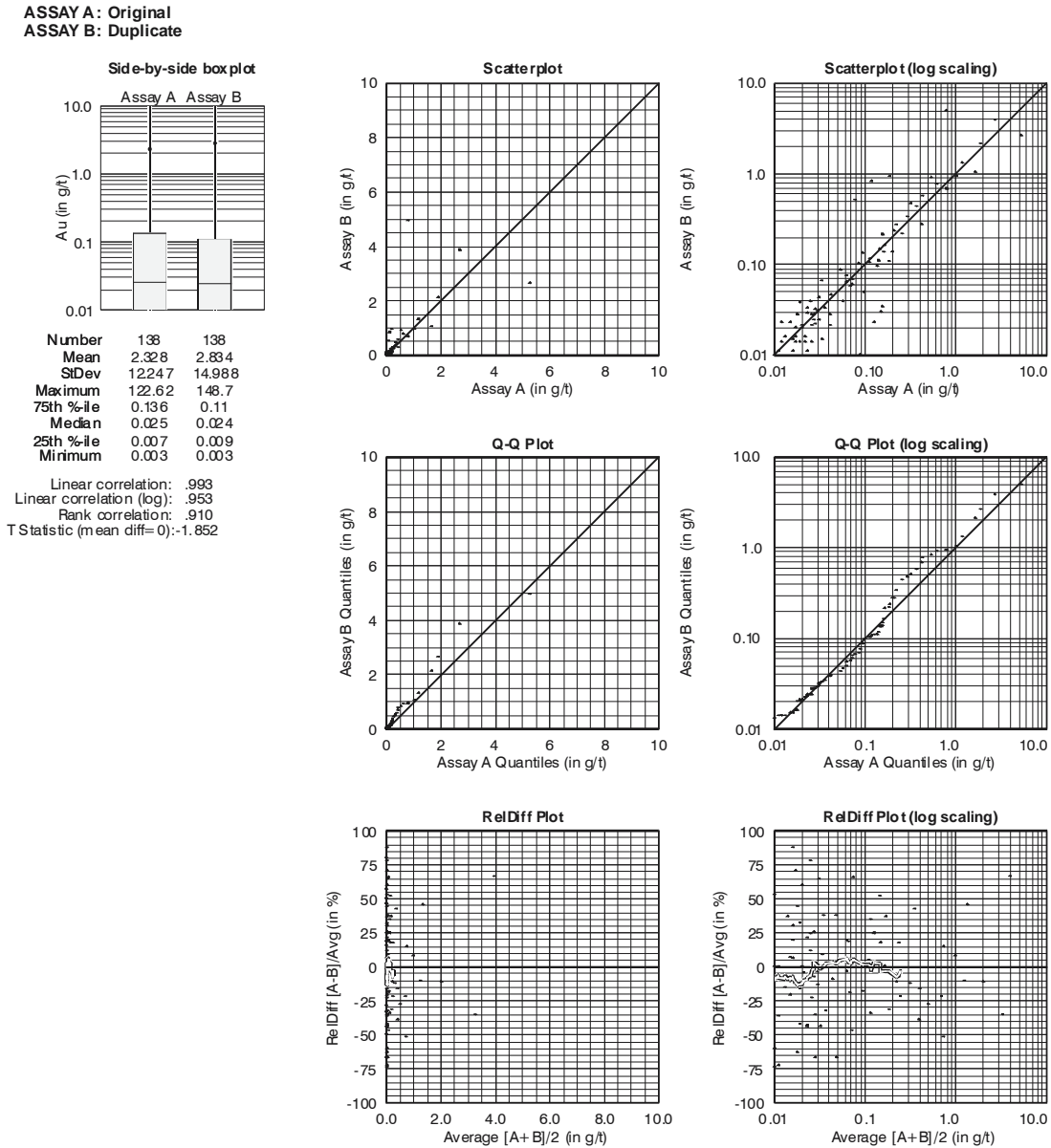

Similar relationships were seen for the 138 duplicate quarter core silver assays. Based on a review of the San Luis QA/QC data, which was vetted by the previous NI 43-101 report (Blanchflower, 2007), it is the authors opinion that the assay data have been reasonably verified given and are suitable for estimating Mineral Resources.

15.0 ADJACENT PROPERTIES

Although there are several mineral concessions in the immediate vicinity of the property that are not controlled by Esperanza – Silver Standard joint venture, none of these properties are currently being explored, or have any documented mineral occurrences.

16.0 MINERAL PROCESSING AND METALLURGICAL TESTING

During 2007, preliminary metallurgical testwork was completed on core from the Ayelén vein. The testwork was directed by F. Wright Consulting Inc. of North Vancouver, B.C., Canada. The actual testwork was done primarily by Process Research Associates Ltd. (PRA) of Richmond, BC. Related chemical analyses were performed by iPL Laboratory of Richmond BC.

16.1 Metallurgical Composite Samples

The preliminary metallurgical testwork was completed on five individual composite samples of diamond drill core that were put together from the following 15 holes drilled during the 2006 and 2007 exploration seasons:

SL06-01
SL06-03
SL06-04
SL06-10
SL06-13
SL06-16
SL06-17
SL06-25
SL07-001
SL07-006
SL07-010
A-SL-023
A-SL-028
A-SL-030
A-SL-033

Table 16-1: Metallurgical Composite Head Grade Analyses
(Excerpted from Table 4.1: Head Analyses, Wright (2008))

Composite ID	Au (g/t)	Ag (g/t)	%S
Aylene 1	45.3	892	0.23
Aylene 2	22.9	676	0.09
Aylene 3	9.46	291	0.31
Aylene 4	10.3	348	0.29
Aylene 5	26.1	762	0.37

As noted in the test report (Wright, 2008): “The head assays show a ratio of approximately 30 to 1 silver to gold, for four of the five composites. The exception was Aylene #1, which had a silver to gold ratio of about 20:1, as well as the highest gold grade of 45.3 g/t Au. Metallic gold analyses (see Appendix 2) indicated some coarse gold to be present, with the highest amount analyzed for Aylene #1 having 101 g/t Au in the coarse

fraction, verses 41.4 g/t in the pulverized fraction. Gold and silver assays verses particle size was also undertaken and showed a relatively even distribution of precious metal content.”

In REI’s opinion, these metallurgical composites adequately represent the average gold and silver grades of the updated Mineral Resource, and also adequately represent the spatial distribution of the Mineral Resources.

16.2 Test Procedures

The metallurgical testwork included comminution, gravity, cyanidation, and froth flotation procedures to determine preliminary gold and silver recoveries. All tests were open cycle, with the baseline testwork done using the Ayelén 1, Ayelén 4, and Ayelén 5 composites. Subsequent confirmation testing used composites Ayelén 2 and Ayelén 3.

As described in Wright (2008): “Primary grinding was performed in a stainless steel laboratory rod mill. Test grinds were used to calculate the time requirements to meet specified targeted particle size distribution. A standard charge to the mill is slurried to ~65% by weight solids content, and a particle size analysis is performed on the ground product. For some of the bench scale tests where fine primary grinding was used the fine fraction was screened off to reduce over grinding. The coarse fraction was then reground in a small ball mill to better simulate plant conditions, where coarse material would normally be recycled back to the mill via the cyclone underflow. Particle size analyses was undertaken for each ground sample using a Rotap™ equipped with 20 cm (8”) diameter test sieves, stacked in ascending mesh sizes. Each sample was initially wet screened at 37 microns (400 Tyler™ mesh). The +37 micron fraction was then dried and re-screened through the stacked sieves. Each sieved fraction was collected, weighed, and the individual and cumulative percent retained calculated. A Coulter® analyzer was used for providing particle size in finer product streams.”

The tests are summarized as follows:

Comminution

According to Wright (2008), *“Bond Ball Mill Work Index tests were performed on each of the composites using a closing screen size of 74 microns (200 Tyler mesh).*

Gravity Testwork

As described in Wright (2008), “For gravity recovery the sample was ground to the specified target particle size, re-pulped to approximately 20% solids by weight, and subjected to a single pass through a Knelson® centrifugal laboratory concentrator. The equipment was set to produce 60 G-force. The resulting Knelson concentrate was hand-panned to simulate a plant gravity upgrading circuit (typically by tabling), and the entire pan concentrate was fire assayed for gold and silver. The combined (Knelson and pan) gravity tailings were submitted for further processing by either cyanidation or flotation.”

Flotation Testwork

As described in Wright (2008), “A series of open cycle, bench scale flotation tests were undertaken using typical conditions for a Denver D12 laboratory machine. The batch feed was typically 2 kg of sample placed in a flotation cell of a specific known volume (usually 5 L to produce a standard pulp density 33% solids by weight). The solids were pulped in potable municipal water at ambient temperature. The D12 impeller speed was set at the required rate according to cell size and the airflow was controlled manually to maintain the froth level. Two reagents consisting of potassium amyl xanthate (PAX) and A208 as were used in equal ratios collectors for precious metal and sulfide minerals. Other principal reagents included copper sulphate (CuSO₄) as an activating agent, and methyl iso-butyl carbinol (MIBC) as the frother. The initial tests applied kinetic flotation procedures at various grinds to produce timed stages of rougher concentrate. This was followed by cleaning flotation studies performed on a bulk rougher concentrate at pre-established conditions.”

16.3 Test Results

The preliminary metallurgical test results are summarized in Table 16-2:

Table 16-2: Preliminary Metallurgical Test Results
(Excerpted from Wright 2008)

Composite ID	Flotation Recovery Percentage		Cyanidation Recovery Percentage ¹		CN Float Tail ²	
	Au	Ag	Au	Ag	Au	Ag
Aylene 1	93.5	89.2	97.8	88.6	~99	97.9
Aylene 2	85.3	79.8	98.5	89	~100	94.8
Aylene 3	87.9	75.7	96.8	73.2	~101	97.3
Aylene 4	87.9	72.7	96.7	89.1	~102	96.5
Aylene 5	93.8	88.2	97.4	89.5	~103	92.8

¹ Cyanidation includes gravity

² Cyanidation (CN) on float tail

As summarized by Wright (2008):

“The studies showed the ore to have a moderate hardness of 14-15 kWh/tonne, as measured by the Bond Ball Mill Work Index.”

“Process testing showed gravity recovery obtained 10% to 24% of the contained gold into a gravity concentrate. The use of gravity pretreatment did not reduce the loss of precious metals into the flotation tailing, but should improve cyanide leach kinetics. Consequently, gravity pretreatment is recommended prior to cyanidation, particularly for higher grade feeds. Finer grinding was shown to be necessary to maximize metal recovery using either cyanidation or flotation procedures, particularly on higher grade samples. “

“The flotation recoveries, especially for gold, are lower than for cyanidation. Using both processes together (cyaniding the flotation tailing) resulted in the highest precious metal recoveries.”

16.4 Conclusions

As summarized by Wright (2008): *“Cyanidation provides the best gold recoveries, ranging from the mid to high nineties depending on the sample and pretreatment procedures used. The test program showed that the San Luis samples responded well to all of conventional mineral processing procedures tested. Further laboratory studies are warranted as the project proceeds to better define the most appropriate treatment.”*

17.0 MINERAL RESOURCE AND MINERAL RESERVE ESTIMATES

RMI obtained various sample data from SSRI, performed various statistical analyses, constructed a series of vein wireframes, and estimated Mineral Resources for the Ayelén and Inéz deposits. The following section briefly describes the methods that were used and subsequent tally of Mineral Resources.

17.1 Sample Data

Gold and silver assay data were initially collected from HQ core holes and surface chip-channel samples as described in Sections 10.0 through 12.0. These data were provided in the form of Excel spreadsheets and contained collar coordinate locations, down-hole surveys, assay grades, and lithologic codes. Basic descriptive statistics are summarized in Section 17.5. RMI notes that assay data for drill holes A-SL-127 and A-SL-128 were used to estimate Mineral Resources and were unavailable for a previous estimate (Blanchflower, 2007). In addition, RMI used more surface trench sample data for identifying the mineralized portions of the Ayelén and Inéz veins than Blanchflower.

17.2 Geologic Data

Logged lithologic codes were provided for the drill hole and channel samples which were used to construct mineralized wireframes that were subsequently used in the grade estimation process. In addition, the authors relied heavily on a set of 1:500 scale geologic cross sections that were prepared by Mr. Ken Konkin.

17.3 Topographic Data

SSRI provided the authors with an AutoCAD DXF file which contained topographic contours at an interval of 2 meters. According to SSRI personnel, the contour data were obtained from Ikonos satellite stereo pair photographs. RMI constructed a three-dimensional surface from the contours and used this surface to code block topo (rock) percentages.

17.4 Bulk Density Data

Bulk density (specific gravity) data were provided for 353 drill core samples from the Ayelén and Inéz veins. These determinations were made by taking the average of weighing the sample in air five times (each time after being dried in an oven so as to remove moisture), followed by the average of five measurements of the core sample length and the average of five measurements of the core diameter. These determinations were completed for approximately 30 different logged lithologies as summarized in Table 17-1.

Table 17-1: Bulk Density Values by Logged Lithologies

Logged Lithology	Description	Count	SG (g/cm³)
FZ	Fault zone	1	2.52
H1	Vein	19	2.58
H1bd	Vein	9	2.60
H1bx	Vein	45	2.60
H1cb	Vein	13	2.61
H1m	Vein	3	2.59
H2	Vein	1	2.54
H2bd	Vein	1	2.62
H2bx	Vein	10	2.62
H2cb	Vein	1	2.59
H5	Vein	1	2.65
H5bx	Vein	4	2.77
H5m	Vein	1	2.66
H7	Vein	81	2.62
H7cb	Vein	2	2.61
I2	Intrusive dike	5	2.61
I2fb	Intrusive dike	8	2.60
I2fp	Intrusive dike	7	2.58
I2qfp	Intrusive dike	5	2.62
I2qp	Intrusive dike	4	2.60
I2sphl	Intrusive dike	2	2.57
I3	Intrusive dike	1	2.65
Tbx	Breccia	1	2.67
V4	Lower volcanic sequence	12	2.66
V4at	Upper volcanic sequence	1	2.67
V4fbx	Upper volcanic sequence	10	2.68
V4fp	Upper volcanic sequence	35	2.66
V4lpt	Upper volcanic sequence	28	2.65
V4mp	Upper volcanic sequence	19	2.67
V4tbx	Upper volcanic sequence	23	2.65
Grand Total		353	2.63

The bulk density measurements shown in Table 17-1 were combined into four categories (vein, dike, upper and lower volcanic sequences) so that values could be calculated. Table 17-2 summarizes those averages.

Table 17-2: Bulk Density Values by Combined Lithologic Units

Combined Lithologic Units	Count	SG (g/cm ³)
Dike	32	2.60
Lower Volc	76	2.66
Upper Volc	52	2.65
Vein	193	2.61
Grand Total	353	2.63

Based on the averages shown in Table 17-2, RMI elected to use a bulk density value of 2.61 g/cm³ for vein material and 2.65 for all other lithologies for tabulating Mineral Resource tonnages. This compares very closely with the bulk density values used in the previous resource estimate of 2.608, 2.605 and 2.587 g/cm³ for the Ayelén hangingwall, Ayelén footwall, and Inéz veins, respectively (Blanchflower, 2007).

17.5 Assay Statistics

Basic descriptive statistics were calculated for raw and capped precious metal assays by area, sample type, rock type, and mineralized zone. These statistics show the number of meters, mean grades, grade-thickness products, standard deviations, and coefficients of variation at four cutoff grades. Gold statistics are shown in Tables 17-3 through 17-6 and silver statistics are summarized in Tables 17-7 through 17-10. Assay capping limits are discussed in Section 17.6.

The assay statistics summarized in Tables 17-3 through 17-10 show that both gold and silver have relatively high coefficients of variation (standard deviation/mean) which is not unusual for epithermal precious metal deposits.

Table 17-3: Au Assay Statistics by Area

AREA	Uncapped Au Statistics Above Cutoff								Capped Au Statistics Above Cutoff				
	Au Cutoff g/t	Total Meters	Inc. Percent	Mean Au g/t	Grd-Thk (g/t-m)	Inc. Percent	Std. Dev.	Coeff. of Variation	Mean Au g/t	Grd-Thk (g/t-m)	Inc. Percent	Std. Dev.	Coeff. of Variation
All Data	0.00	5,275	86%	2.38	12,547	2.0%	14.88	6.26	2.14	11,293	2.3%	11.56	5.40
	0.50	763	7%	16.11	12,291	3.7%	36.21	2.25	14.46	11,037	4.1%	27.31	1.89
	3.00	401	2%	29.49	11,831	3.7%	46.00	1.56	26.37	10,577	4.1%	33.46	1.27
	6.00	295	6%	38.52	11,367	90.6%	50.67	1.32	34.27	10,113	89.6%	35.85	1.05
Ayelén	0.00	4,291	84%	2.84	12,183	1.7%	16.41	5.78	2.57	11,021	1.9%	12.76	4.97
	0.50	671	7%	17.85	11,973	3.0%	38.16	2.14	16.12	10,812	3.4%	28.71	1.78
	3.00	384	2%	30.23	11,603	3.6%	46.75	1.55	27.20	10,441	3.9%	33.95	1.25
	6.00	285	7%	39.21	11,169	91.7%	51.31	1.31	35.13	10,008	90.8%	36.18	1.03
Inéz	0.00	983	91%	0.37	363	12.6%	2.83	7.65	0.28	271	16.9%	1.19	4.33
	0.50	93	8%	3.43	318	24.8%	8.63	2.51	2.44	226	33.2%	3.15	1.29
	3.00	17	1%	13.19	228	8.3%	16.75	1.27	7.86	136	11.1%	3.94	0.50
	6.00	10	1%	19.22	197	54.3%	19.53	1.02	10.27	105	38.8%	3.36	0.33

The majority of the assay data were obtained from the Ayelén vein as shown in Table 17-3 with less than 1000 meters of assayed data collected from the lower grade Inéz vein.

Table 17-4: Au Assay Statistics by Sample Type

STYPE	Uncapped Au Statistics Above Cutoff								Capped Au Statistics Above Cutoff				
	Au Cutoff g/t	Total Meters	Inc. Percent	Mean Au g/t	Grd-Thk (g/t-m)	Inc. Percent	Std. Dev.	Coeff. of Variation	Mean Au g/t	Grd-Thk (g/t-m)	Inc. Percent	Std. Dev.	Coeff. of Variation
All Data	0.00	5,275	86%	2.38	12,547	2.0%	14.88	6.26	2.14	11,293	2.3%	11.56	5.40
	0.50	763	7%	16.11	12,291	3.7%	36.21	2.25	14.46	11,037	4.1%	27.31	1.89
	3.00	401	2%	29.49	11,831	3.7%	46.00	1.56	26.37	10,577	4.1%	33.46	1.27
	6.00	295	6%	38.52	11,367	90.6%	50.67	1.32	34.27	10,113	89.6%	35.85	1.05
HQ Core	0.00	4,330	87%	1.91	8,274	2.5%	12.15	6.36	1.78	7,697	2.7%	10.10	5.68
	0.50	562	6%	14.37	8,070	4.2%	30.98	2.16	13.34	7,493	4.5%	25.14	1.88
	3.00	298	2%	25.92	7,725	4.5%	39.03	1.51	23.99	7,148	4.9%	30.81	1.28
	6.00	213	5%	34.57	7,349	88.8%	43.29	1.25	31.86	6,772	88.0%	33.38	1.05
Chip Channel	0.00	944	79%	4.52	4,272	1.2%	23.56	5.21	3.81	3,596	1.4%	16.59	4.36
	0.50	202	10%	20.94	4,221	2.7%	47.52	2.27	17.58	3,544	3.2%	32.38	1.84
	3.00	103	2%	39.81	4,106	2.1%	60.71	1.52	33.25	3,429	2.5%	39.33	1.18
	6.00	83	9%	48.67	4,018	94.0%	64.89	1.33	40.47	3,341	92.9%	40.87	1.01

Approximately 82% of the assayed gold and silver data were derived from HQ core drilling as shown in Table 17-4 with the remainder collected from chip channel samples that were collected from surface trenches.

Table 17-5: Au Assay Statistics by Combined Lithologies

ROCK	Uncapped Au Statistics Above Cutoff								Capped Au Statistics Above Cutoff				
	Au Cutoff g/t	Total Meters	Inc. Percent	Mean Au g/t	Grd-Thk (g/t-m)	Inc. Percent	Std. Dev.	Coeff. of Variation	Mean Au g/t	Grd-Thk (g/t-m)	Inc. Percent	Std. Dev.	Coeff. of Variation
All Data	0.00	5,275	86%	2.38	12,547	2.0%	14.88	6.26	2.14	11,293	2.3%	11.56	5.40
	0.50	763	7%	16.11	12,291	3.7%	36.21	2.25	14.46	11,037	4.1%	27.31	1.89
	3.00	401	2%	29.49	11,831	3.7%	46.00	1.56	26.37	10,577	4.1%	33.46	1.27
	6.00	295	6%	38.52	11,367	90.6%	50.67	1.32	34.27	10,113	89.6%	35.85	1.05
Intrusive Dikes	0.00	788	98%	0.52	407	4.4%	8.23	15.94	0.45	355	5.1%	7.02	15.57
	0.50	16	1%	25.01	389	2.5%	53.08	2.12	21.71	337	2.8%	45.14	2.08
	3.00	5	0%	70.89	379	1.1%	70.66	1.00	61.28	327	1.3%	59.54	0.97
	6.00	4	1%	88.22	374	92.0%	69.51	0.79	76.12	323	90.8%	58.27	0.77
Fault Zones	0.00	149	83%	6.26	930	1.3%	31.63	5.05	4.90	728	1.6%	22.05	4.50
	0.50	25	8%	37.16	918	1.3%	69.80	1.88	28.97	716	1.7%	47.21	1.63
	3.00	13	3%	67.63	906	2.1%	83.45	1.23	52.53	703	2.7%	53.87	1.03
	6.00	9	6%	101.49	886	95.3%	85.94	0.85	78.33	684	94.0%	50.38	0.64
Lower Volcanics	0.00	2,282	95%	0.50	1,139	9.2%	6.35	12.73	0.47	1,076	9.7%	5.67	12.02
	0.50	115	4%	9.02	1,035	9.2%	26.94	2.99	8.47	972	9.7%	23.90	2.82
	3.00	26	0%	35.70	930	3.8%	47.70	1.34	33.27	867	4.0%	41.45	1.25
	6.00	16	1%	56.68	887	77.9%	51.81	0.91	52.65	824	76.6%	43.82	0.83
Talus	0.00	1	100%	0.03	0	100.0%	0.00	0.00	0.03	0	100.0%	0.00	0.00
	0.50	0	0%	0.00	0	0.0%	0.00	0.00	0.00	0	0.0%	0.00	0.00
	3.00	0	0%	0.00	0	0.0%	0.00	0.00	0.00	0	0.0%	0.00	0.00
	6.00	0	0%	0.00	0	0.0%	0.00	0.00	0.00	0	0.0%	0.00	0.00
Undefined	0.00	87	91%	0.15	13	21.6%	0.58	3.84	0.15	13	21.6%	0.58	3.84
	0.50	8	9%	1.28	10	50.0%	1.49	1.16	1.28	10	50.0%	1.49	1.16
	3.00	1	0%	6.33	4	0.0%	0.75	0.12	6.33	4	0.0%	0.75	0.12
	6.00	1	1%	6.33	4	28.4%	0.75	0.12	6.33	4	28.4%	0.75	0.12
Upper Volcanics	0.00	659	92%	0.34	226	14.3%	1.73	5.02	0.34	226	14.3%	1.73	5.02
	0.50	53	5%	3.69	194	17.6%	5.00	1.36	3.69	194	17.6%	5.00	1.36
	3.00	20	2%	7.82	154	25.2%	6.22	0.80	7.82	154	25.2%	6.22	0.80
	6.00	7	1%	13.13	97	42.9%	7.54	0.57	13.13	97	42.9%	7.54	0.57
Vein Material	0.00	1,309	58%	7.51	9,831	0.9%	25.06	3.34	6.79	8,894	1.0%	19.10	2.81
	0.50	547	16%	17.80	9,745	2.9%	36.32	2.04	16.09	8,808	3.2%	26.91	1.67
	3.00	336	6%	28.15	9,459	3.5%	43.26	1.54	25.36	8,522	3.8%	30.93	1.22
	6.00	259	20%	35.27	9,119	92.8%	47.04	1.33	31.65	8,182	92.0%	32.73	1.03

The various rock types shown in Table 17-5 were combined from the various logged lithologic units to provide enough samples for more representative statistics. A significant amount of upper and lower volcanic material was not assayed.

Table 17-6: Au Assay Statistics by Mineralized Zone

MZONE	Uncapped Au Statistics Above Cutoff								Capped Au Statistics Above Cutoff				
	Au Cutoff g/t	Total Meters	Inc. Percent	Mean Au g/t	Grd-Thk (g/t-m)	Inc. Percent	Std. Dev.	Coeff. of Variation	Mean Au g/t	Grd-Thk (g/t-m)	Inc. Percent	Std. Dev.	Coeff. of Variation
All Data	0.00	5,275	86%	2.38	12,547	2.0%	14.88	6.26	2.14	11,293	2.3%	11.56	5.40
	0.50	763	7%	16.11	12,291	3.7%	36.21	2.25	14.46	11,037	4.1%	27.31	1.89
	3.00	401	2%	29.49	11,831	3.7%	46.00	1.56	26.37	10,577	4.1%	33.46	1.27
	6.00	295	6%	38.52	11,367	90.6%	50.67	1.32	34.27	10,113	89.6%	35.85	1.05
1	0.00	57	15%	2.10	120	1.6%	3.55	1.69	2.10	120	1.6%	3.55	1.69
	0.50	49	71%	2.42	118	39.4%	3.75	1.55	2.42	118	39.4%	3.75	1.55
	3.00	8	6%	8.51	71	13.5%	5.98	0.70	8.51	71	13.5%	5.98	0.70
	6.00	5	8%	11.83	55	45.6%	6.29	0.53	11.83	55	45.6%	6.29	0.53
10	0.00	528	17%	20.25	10,693	0.2%	42.43	2.10	18.07	9,540	0.2%	31.74	1.76
	0.50	436	28%	24.48	10,673	1.9%	45.59	1.86	21.84	9,521	2.1%	33.74	1.55
	3.00	289	12%	36.30	10,475	2.6%	52.21	1.44	32.31	9,323	3.0%	37.36	1.16
	6.00	224	42%	45.49	10,192	95.3%	55.97	1.23	40.35	9,040	94.8%	38.84	0.96
11	0.00	119	11%	7.66	910	0.4%	10.08	1.32	7.66	910	0.4%	10.08	1.32
	0.50	106	38%	8.56	906	7.4%	10.32	1.21	8.56	906	7.4%	10.32	1.21
	3.00	61	17%	13.80	839	9.8%	10.98	0.80	13.80	839	9.8%	10.98	0.80
	6.00	41	34%	18.37	750	82.4%	10.75	0.59	18.37	750	82.4%	10.75	0.59
12	0.00	6	30%	2.35	15	3.9%	2.19	0.93	2.35	15	3.9%	2.19	0.93
	0.50	4	46%	3.21	14	36.7%	2.07	0.64	3.21	14	36.7%	2.07	0.64
	3.00	2	10%	5.72	9	18.3%	1.34	0.23	5.72	9	18.3%	1.34	0.23
	6.00	1	14%	6.88	6	41.1%	0.00	0.00	6.88	6	41.1%	0.00	0.00
13	0.00	8	11%	5.16	43	0.3%	4.55	0.88	5.16	43	0.3%	4.55	0.88
	0.50	8	30%	5.76	43	4.5%	4.45	0.77	5.76	43	4.5%	4.45	0.77
	3.00	5	25%	8.26	41	25.2%	3.31	0.40	8.26	41	25.2%	3.31	0.40
	6.00	3	34%	10.47	30	70.0%	2.65	0.25	10.47	30	70.0%	2.65	0.25
14	0.00	4	0%	13.38	49	0.0%	11.32	0.85	13.38	49	0.0%	11.32	0.85
	0.50	4	26%	13.38	49	1.6%	11.32	0.85	13.38	49	1.6%	11.32	0.85
	3.00	3	0%	17.80	48	0.0%	9.91	0.56	17.80	48	0.0%	9.91	0.56
	6.00	3	74%	17.80	48	98.4%	9.91	0.56	17.80	48	98.4%	9.91	0.56
15	0.00	5	0%	6.68	30	0.0%	9.47	1.42	6.68	30	0.0%	9.47	1.42
	0.50	5	28%	6.68	30	5.2%	9.47	1.42	6.68	30	5.2%	9.47	1.42
	3.00	3	32%	8.76	29	19.0%	10.42	1.19	8.76	29	19.0%	10.42	1.19
	6.00	2	41%	12.48	23	75.8%	12.72	1.02	12.48	23	75.8%	12.72	1.02
16	0.00	6	5%	2.83	17	0.1%	2.29	0.81	2.83	17	0.1%	2.29	0.81
	0.50	6	55%	2.98	17	26.2%	2.26	0.76	2.98	17	26.2%	2.26	0.76
	3.00	2	18%	5.20	13	20.6%	1.80	0.35	5.20	13	20.6%	1.80	0.35
	6.00	1	22%	6.75	9	53.1%	0.67	0.10	6.75	9	53.1%	0.67	0.10
20	0.00	80	14%	4.00	320	0.9%	9.52	2.38	2.73	219	1.3%	3.64	1.33
	0.50	68	62%	4.63	317	20.1%	10.16	2.19	3.15	216	29.3%	3.78	1.20
	3.00	19	8%	13.61	253	8.9%	16.38	1.20	8.16	152	13.0%	4.13	0.51
	6.00	12	15%	18.85	225	70.2%	18.48	0.98	10.36	123	56.4%	3.59	0.35
99	0.00	4,462	98%	0.08	349	65.0%	0.31	3.92	0.08	349	65.0%	0.31	3.92
	0.50	78	2%	1.56	122	19.8%	1.65	1.06	1.56	122	19.8%	1.65	1.06
	3.00	10	0%	5.34	53	7.1%	1.63	0.31	5.34	53	7.1%	1.63	0.31
	6.00	4	0%	7.06	28	8.1%	0.73	0.10	7.06	28	8.1%	0.73	0.10

The mineralized zones shown in Table 17-6 are described in Section 17.8.

Table 17-7: Ag Assay Statistics by Area

AREA	Uncapped Ag Statistics Above Cutoff								Capped Ag Statistics Above Cutoff				
	Ag Cutoff g/t	Total Meters	Inc. Percent	Mean Ag g/t	Grd-Thk (g/t-m)	Inc. Percent	Std. Dev.	Coeff. of Variation	Mean Ag g/t	Grd-Thk (g/t-m)	Inc. Percent	Std. Dev.	Coeff. of Variation
All Data	0	5,275	67%	65	343,317	1.4%	326	5.01	58	306,917	1.6%	242	4.16
	5	1,747	18%	194	338,371	3.3%	545	2.81	173	301,971	3.7%	397	2.30
	30	805	4%	406	326,873	2.9%	749	1.84	361	290,474	3.2%	526	1.46
	60	573	11%	553	316,964	92.3%	844	1.53	490	280,565	91.4%	575	1.17
Ayelén	0	4,291	66%	76	327,240	1.2%	359	4.71	68	291,925	1.3%	266	3.91
	5	1,443	17%	224	323,322	2.7%	592	2.64	200	288,007	3.0%	430	2.15
	30	716	4%	439	314,510	2.4%	784	1.79	390	279,195	2.7%	548	1.40
	60	530	12%	578	306,569	93.7%	870	1.50	512	271,253	92.9%	590	1.15
Inéz	0	983	69%	16	16,077	6.4%	71	4.33	15	14,993	6.9%	58	3.79
	5	304	22%	49	15,049	16.7%	121	2.45	46	13,965	17.9%	97	2.12
	30	89	5%	140	12,362	12.2%	197	1.41	127	11,278	13.1%	151	1.19
	60	43	4%	242	10,395	64.7%	244	1.01	217	9,311	62.1%	178	0.82

Table 17-8: Ag Assay Statistics by Sample Type

STYPE	Uncapped Ag Statistics Above Cutoff								Capped Ag Statistics Above Cutoff				
	Ag Cutoff g/t	Total Meters	Inc. Percent	Mean Ag g/t	Grd-Thk (g/t-m)	Inc. Percent	Std. Dev.	Coeff. of Variation	Mean Ag g/t	Grd-Thk (g/t-m)	Inc. Percent	Std. Dev.	Coeff. of Variation
All Data	0	5,275	67%	65	343,317	1.4%	326	5.01	58	306,917	1.6%	242	4.16
	5	1,747	18%	194	338,371	3.3%	545	2.81	173	301,971	3.7%	397	2.30
	30	805	4%	406	326,873	2.9%	749	1.84	361	290,474	3.2%	526	1.46
	60	573	11%	553	316,964	92.3%	844	1.53	490	280,565	91.4%	575	1.17
HQ Core	0	4,330	71%	56	244,397	1.7%	294	5.21	51	222,248	1.9%	221	4.31
	5	1,258	15%	191	240,259	3.3%	522	2.73	173	218,109	3.6%	384	2.21
	30	587	4%	396	232,231	2.7%	711	1.80	358	210,081	3.0%	502	1.40
	60	433	10%	520	225,603	92.3%	791	1.52	469	203,454	91.5%	541	1.15
Chip Channel	0	944	48%	105	98,920	0.8%	442	4.22	90	84,670	1.0%	320	3.57
	5	490	29%	200	98,112	3.5%	598	2.99	171	83,862	4.1%	429	2.50
	30	218	8%	435	94,642	3.3%	841	1.93	369	80,392	3.9%	585	1.58
	60	140	15%	655	91,361	92.4%	984	1.50	553	77,111	91.1%	664	1.20

Table 17-9: Ag Assay Statistics by Rock Type

ROCK	Uncapped Ag Statistics Above Cutoff								Capped Ag Statistics Above Cutoff				
	Ag Cutoff g/t	Total Meters	Inc. Percent	Mean Ag g/t	Grd-Thk (g/t-m)	Inc. Percent	Std. Dev.	Coeff. of Variation	Mean Ag g/t	Grd-Thk (g/t-m)	Inc. Percent	Std. Dev.	Coeff. of Variation
All Data	0	5,275	67%	65	343,317	1.4%	326	5.01	58	306,917	1.6%	242	4.16
	5	1,747	18%	194	338,371	3.3%	545	2.81	173	301,971	3.7%	397	2.30
	30	805	4%	406	326,873	2.9%	749	1.84	361	290,474	3.2%	526	1.46
	60	573	11%	553	316,964	92.3%	844	1.53	490	280,565	91.4%	575	1.17
Intrusive Dikes	0	788	83%	14	11,130	6.4%	168	11.90	12	9,503	7.5%	130	10.78
	5	131	12%	80	10,416	9.9%	406	5.10	67	8,789	11.6%	313	4.66
	30	33	3%	284	9,318	8.2%	776	2.73	234	7,690	9.6%	595	2.54
	60	12	2%	695	8,405	75.5%	1169	1.68	561	6,778	71.3%	890	1.59
Fault Zones	0	149	52%	146	21,662	0.7%	602	4.13	120	17,801	0.8%	442	3.69
	5	72	30%	300	21,515	2.5%	840	2.80	246	17,654	3.0%	611	2.48
	30	27	6%	773	20,980	1.7%	1226	1.59	631	17,119	2.1%	865	1.37
	60	18	12%	1140	20,611	95.1%	1361	1.19	926	16,750	94.1%	929	1.00
Lower Volcanics	0	2,282	78%	15	35,248	7.1%	139	8.99	14	32,693	7.6%	107	7.46
	5	493	15%	66	32,751	11.3%	293	4.41	61	30,196	12.2%	224	3.65
	30	155	4%	185	28,754	9.8%	502	2.71	169	26,199	10.5%	376	2.23
	60	73	3%	347	25,306	71.8%	699	2.01	312	22,750	69.6%	513	1.64
Talus	0	1	0%	13	8	0.0%	0	0.00	13	8	0.0%	0	0.00
	5	1	100%	13	8	100.0%	0	0.00	13	8	100.0%	0	0.00
	30	0	0%	0	0	0.0%	0	0.00	0	0	0.0%	0	0.00
	60	0	0%	0	0	0.0%	0	0.00	0	0	0.0%	0	0.00
Undefined	0	87	77%	8	712	15.2%	25	3.02	8	712	15.2%	25	3.02
	5	20	16%	30	604	18.2%	45	1.49	30	604	18.2%	45	1.49
	30	6	4%	79	474	21.1%	57	0.73	79	474	21.1%	57	0.73
	60	2	2%	150	323	45.4%	35	0.23	150	323	45.4%	35	0.23
Upper Volcanics	0	659	75%	16	10,544	6.3%	80	4.98	16	10,544	6.3%	80	4.98
	5	166	18%	59	9,882	12.4%	150	2.53	59	9,882	12.4%	150	2.53
	30	48	3%	178	8,573	7.7%	241	1.36	178	8,573	7.7%	241	1.36
	60	29	4%	268	7,760	73.6%	277	1.03	268	7,760	73.6%	277	1.03
Vein Material	0	1,309	34%	202	264,012	0.3%	554	2.75	180	235,656	0.3%	400	2.22
	5	865	25%	304	263,194	1.7%	659	2.17	271	234,838	1.9%	466	1.72
	30	535	7%	484	258,774	1.6%	786	1.62	431	230,418	1.8%	534	1.24
	60	439	34%	580	254,559	96.4%	837	1.44	516	226,203	96.0%	555	1.08

Table 17-10: Ag Assay Statistics by Mineralized Zone

MZONE	Uncapped Ag Statistics Above Cutoff								Capped Ag Statistics Above Cutoff				
	Ag Cutoff g/t	Total Meters	Inc. Percent	Mean Ag g/t	Grd-Thk (g/t-m)	Inc. Percent	Std. Dev.	Coeff. of Variation	Mean Ag g/t	Grd-Thk (g/t-m)	Inc. Percent	Std. Dev.	Coeff. of Variation
All Data	0	5,275	67%	65	343,317	1.4%	326	5.01	58	306,917	1.6%	242	4.16
	5	1,747	18%	194	338,371	3.3%	545	2.81	173	301,971	3.7%	397	2.30
	30	805	4%	406	326,873	2.9%	749	1.84	361	290,474	3.2%	526	1.46
	60	573	11%	553	316,964	92.3%	844	1.53	490	280,565	91.4%	575	1.17
1	0	57	5%	114	6,493	0.1%	163	1.44	114	6,493	0.1%	163	1.44
	5	54	28%	120	6,485	4.2%	166	1.38	120	6,485	4.2%	166	1.38
	30	38	24%	164	6,213	8.5%	181	1.10	164	6,213	8.5%	181	1.10
	60	24	43%	233	5,661	87.2%	194	0.83	233	5,661	87.2%	194	0.83
10	0	528	5%	493	260,139	0.0%	890	1.81	427	225,359	0.0%	615	1.44
	5	501	14%	519	260,068	0.5%	906	1.75	449	225,288	0.6%	623	1.39
	30	427	13%	606	258,814	1.2%	955	1.58	525	224,034	1.4%	646	1.23
	60	357	68%	717	255,745	98.3%	1008	1.41	619	220,965	98.0%	667	1.08
11	0	119	1%	276	32,758	0.0%	289	1.05	276	32,758	0.0%	289	1.05
	5	117	11%	279	32,756	0.7%	290	1.04	279	32,756	0.7%	290	1.04
	30	105	16%	310	32,541	2.6%	291	0.94	310	32,541	2.6%	291	0.94
	60	86	73%	368	31,695	96.8%	291	0.79	368	31,695	96.8%	291	0.79
12	0	6	0%	122	765	0.0%	76	0.62	122	765	0.0%	76	0.62
	5	6	14%	122	765	0.9%	76	0.62	122	765	0.9%	76	0.62
	30	5	0%	140	758	0.0%	65	0.46	140	758	0.0%	65	0.46
	60	5	86%	140	758	99.1%	65	0.46	140	758	99.1%	65	0.46
13	0	8	0%	279	2,347	0.0%	285	1.02	279	2,347	0.0%	285	1.02
	5	8	21%	279	2,347	1.0%	285	1.02	279	2,347	1.0%	285	1.02
	30	7	11%	349	2,323	1.5%	282	0.81	349	2,323	1.5%	282	0.81
	60	6	68%	397	2,288	97.5%	273	0.69	397	2,288	97.5%	273	0.69
14	0	4	0%	478	1,744	0.0%	335	0.70	478	1,744	0.0%	335	0.70
	5	4	0%	478	1,744	0.0%	335	0.70	478	1,744	0.0%	335	0.70
	30	4	26%	478	1,744	2.3%	335	0.70	478	1,744	2.3%	335	0.70
	60	3	74%	631	1,704	97.7%	247	0.39	631	1,704	97.7%	247	0.39
15	0	5	0%	395	1,782	0.0%	1058	2.68	276	1,246	0.0%	453	1.64
	5	5	28%	395	1,782	1.7%	1058	2.68	276	1,246	2.4%	453	1.64
	30	3	0%	537	1,752	0.0%	1215	2.26	373	1,216	0.0%	501	1.34
	60	3	72%	537	1,752	98.3%	1215	2.26	373	1,216	97.6%	501	1.34
16	0	6	5%	74	447	0.0%	54	0.73	74	447	0.0%	54	0.73
	5	6	15%	78	447	4.2%	53	0.68	78	447	4.2%	53	0.68
	30	5	23%	88	428	10.5%	51	0.58	88	428	10.5%	51	0.58
	60	3	57%	111	381	85.2%	43	0.39	111	381	85.2%	43	0.39
20	0	80	0%	123	9,856	0.0%	204	1.66	110	8,772	0.0%	154	1.41
	5	80	32%	123	9,856	4.3%	204	1.66	110	8,772	4.9%	154	1.41
	30	54	28%	174	9,428	10.6%	231	1.33	154	8,344	11.9%	170	1.11
	60	32	39%	266	8,382	85.0%	268	1.01	232	7,298	83.2%	188	0.81
99	0	4,462	78%	6	26,986	18.0%	27	4.44	6	26,986	18.0%	27	4.44
	5	966	18%	23	22,121	34.3%	54	2.37	23	22,121	34.3%	54	2.37
	30	157	2%	82	12,872	15.8%	118	1.44	82	12,872	15.8%	118	1.44
	60	54	1%	160	8,599	31.9%	176	1.10	160	8,599	31.9%	176	1.10

Figures 17-1 and 17-2 are box plots that compare select raw uncapped gold and silver assay data by logged lithologies, respectively. Box plots show pertinent information like minimum grade, maximum grade, first and second quartile grades, median grade, and mean grade. The preferential vein host rocks (“H”-series lithologic codes) show significantly higher grades than other lithologic units.

Based on relatively similar metal distributions, all of the logged vein lithologies were combined and modeled for the purpose of estimating Mineral Resources (refer to Section 17-11).

Figure 17-1: Au Box Plot For Select Lithologic Units

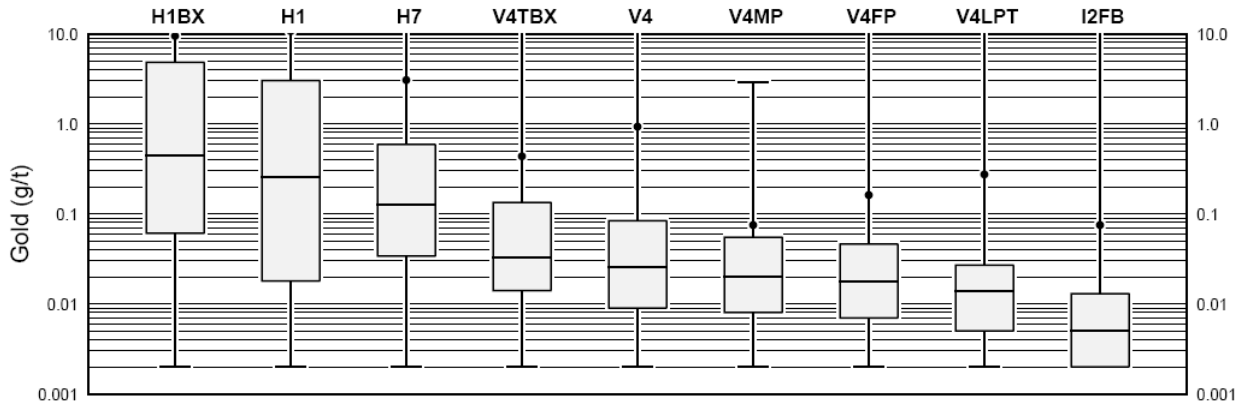

	H1BX	H1	H7	V4TBX	V4	V4MP	V4FP	V4LPT	I2FB	
Number of data	306	245	596	317	530	410	998	325	266	Number of data
Mean	9.444	10.682	3.063	0.436	0.929	0.075	0.162	0.274	0.075	Mean
Maximum	260.19	434.37	151.36	25.7	180.12	2.89	105.12	30.3	168.82	Maximum
Upper quartile	4.829	3.034	0.589	0.134	0.084	0.055	0.046	0.027	0.013	Upper quartile
Median	0.439	0.257	0.126	0.033	0.026	0.02	0.018	0.014	0.005	Median
Lower quartile	0.061	0.018	0.034	0.014	0.009	0.008	0.007	0.005	0.002	Lower quartile
Minimum	0.002	0.002	0.002	0.002	0.002	0.002	0.002	0.002	0.002	Minimum
Variance	913.831	1446.55	162.543	4.0535	95.9338	0.0603	6.0588	2.1384	9.075	Variance
CV	3.201	3.561	4.162	4.614	10.546	3.253	15.175	5.34	40.211	CV
Skewness	5.804	7.195	7.46	8.975	15.437	8.62	35.767	12.535	55.972	Skewness

Figure 17-2: Ag Box Plot For Select Lithologic Units

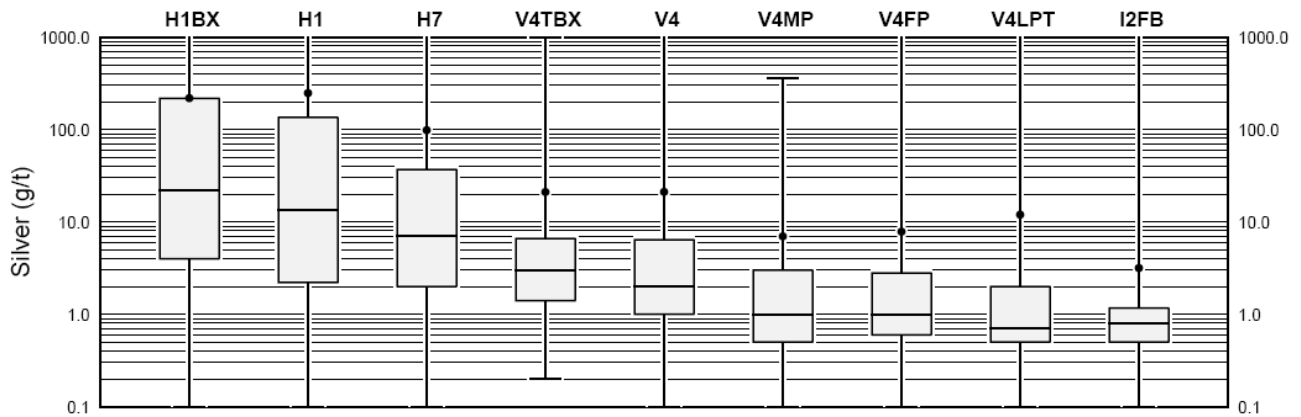

	H1BX	H1	H7	V4TBX	V4	V4MP	V4FP	V4LPT	I2FB	
Number of data	304	245	596	317	529	410	998	325	266	Number of data
Mean	218.662	247.839	98.48	21.104	21.119	6.979	7.847	11.974	3.169	Mean
Maximum	4216.0	4919.0	3793.0	999.0	3102.0	356.0	1740.0	1270.0	2667.0	Maximum
Upper quartile	218.106	134.667	37.0	6.608	6.416	3.0	2.8	2.0	1.166	Upper quartile
Median	22.0	13.54	7.0	3.0	2.0	1.0	1.0	0.7	0.8	Median
Lower quartile	4.0	2.2	2.0	1.4	1.0	0.5	0.6	0.5	0.5	Lower quartile
Minimum	0.1	0.1	0.1	0.2	0.1	0.1	0.1	0.1	0.1	Minimum
Variance	265643.0	505923.0	99232.6	8429.61	23000.8	692.817	4077.1	4742.3	2301.61	Variance
CV	2.357	2.87	3.199	4.35	7.181	3.771	8.137	5.751	15.14	CV
Skewness	4.884	4.411	6.467	7.544	17.192	8.415	22.654	11.927	54.534	Skewness

17.6 Grade Capping

High-grade gold and silver outlier values were capped (cut) to lower values to minimize the risk of overestimating contained metal. Cumulative probability plots and decile analysis were used to determine capping limits. Figures 17-3 and 17-4 are cumulative probability plots that were generated for the Ayelén vein by transforming the grades using the cumulative normal distribution method so that the higher grade population could be examined more closely.

Figure 17-3: Ayelén Au Cumulative Probability Plot

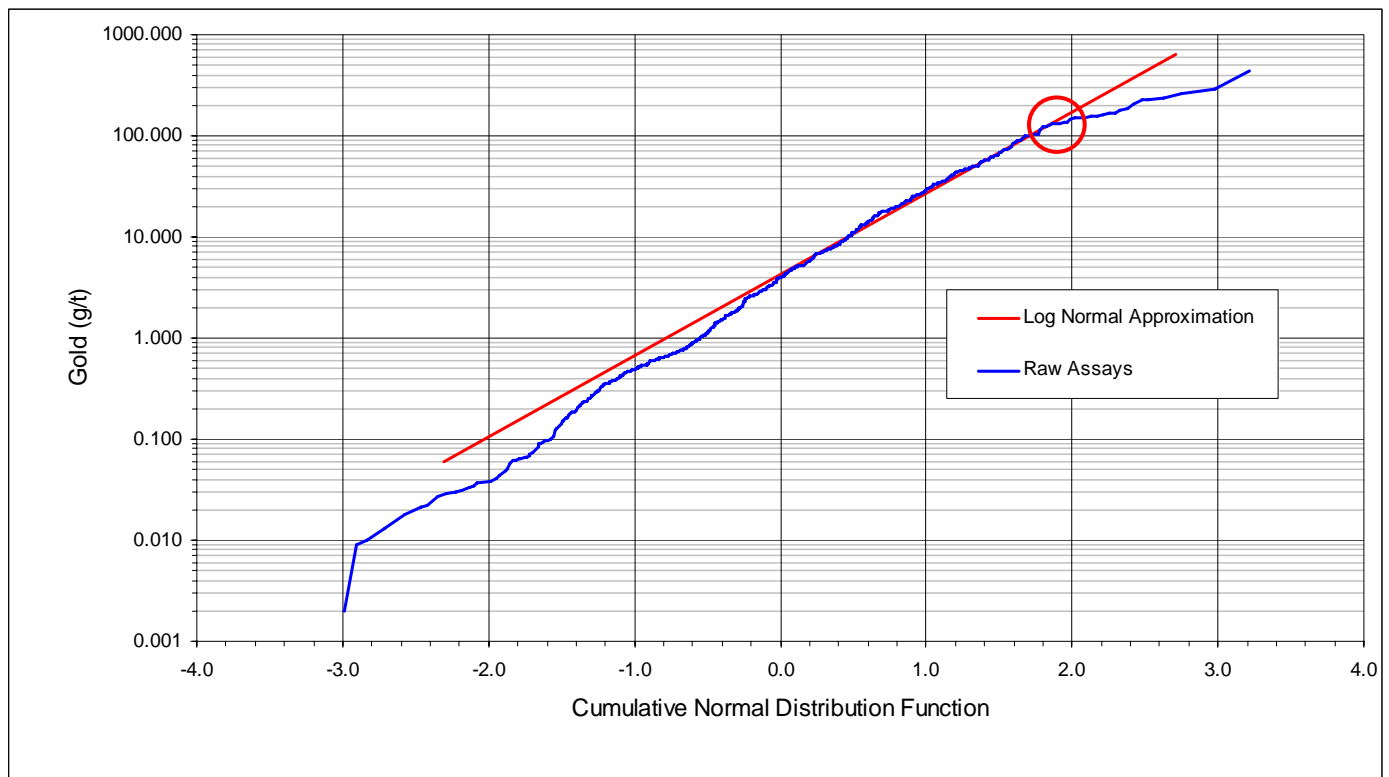

The cumulative probability distribution of gold starts becoming erratic around 130 g/t as shown by the area within the red circle in Figure 17-3. This break in slope is one of the primary reasons that RMI selected a 130 g/t gold cap.

The Ayelén gold assays were broken down into deciles and percentiles as shown in Table 17-11. Approximately 60% of the contained gold metal is contained in 10 percent of the assayed data. Furthermore, the top three percentiles contain over 30% of the contained metal. Based on rules developed by Mr. Irv Parrish, a capping limit of about 130 g/t is indicated based on using the maximum grade of the last percentile that contained less than 10% of the contained metal content. This suggested capping limit compares very well with the cumulative probability plot conclusion.

Table 17-11: Ayelén Au Decile Distribution

<i>Decile</i>	<i>No. Samples</i>	<i>Min Grade</i>	<i>Mean Grade</i>	<i>Max Grade</i>	<i>GxT Product</i>	<i>% of Total</i>
0 - 10	81	0.002	0.116	0.286	7.73	0.07
10 - 20	81	0.290	0.487	0.650	34.87	0.30
20 - 30	81	0.651	0.900	1.305	64.28	0.55
30 - 40	81	1.305	1.903	2.620	125.64	1.08
40 - 50	81	2.640	3.492	4.640	227.10	1.95
50 - 60	81	4.660	5.948	7.560	384.51	3.31
60 - 70	81	7.560	9.903	13.320	591.62	5.09
70 - 80	81	13.470	18.774	25.480	1247.75	10.73
80 - 90	81	25.700	36.505	50.200	2062.53	17.73
90 - 100	81	50.840	116.852	434.370	6888.42	59.21

Total	810	0.002	17.989	434.370	11634.46	100.00
--------------	------------	--------------	---------------	----------------	-----------------	---------------

90 - 91	8	50.840	54.091	58.260	367.82	3.16
91 - 92	8	58.530	60.872	64.680	414.54	3.56
92 - 93	8	65.040	67.746	71.280	285.89	2.46
93 - 94	8	72.190	76.597	83.800	432.77	3.72
94 - 95	8	86.770	93.584	100.000	593.33	5.10
95 - 96	8	101.560	107.778	122.620	649.90	5.59
96 - 97	8	123.310	127.943	131.900	519.45	4.47
97 - 98	8	133.500	144.939	156.120	1208.79	10.39
98 - 99	8	158.910	168.716	183.540	852.02	7.32
99 -100	9	207.000	276.800	434.370	1563.92	13.44

Sub-total	81	50.840	116.852	434.370	6888.42	59.21
------------------	-----------	---------------	----------------	----------------	----------------	--------------

Based on the relationships shown in Figure 17-3 and Table 17-11, the author elected to cap Ayelén gold assays at 130 g/t.

Figure 17-4: Ayelén Ag Cumulative Probability Plot

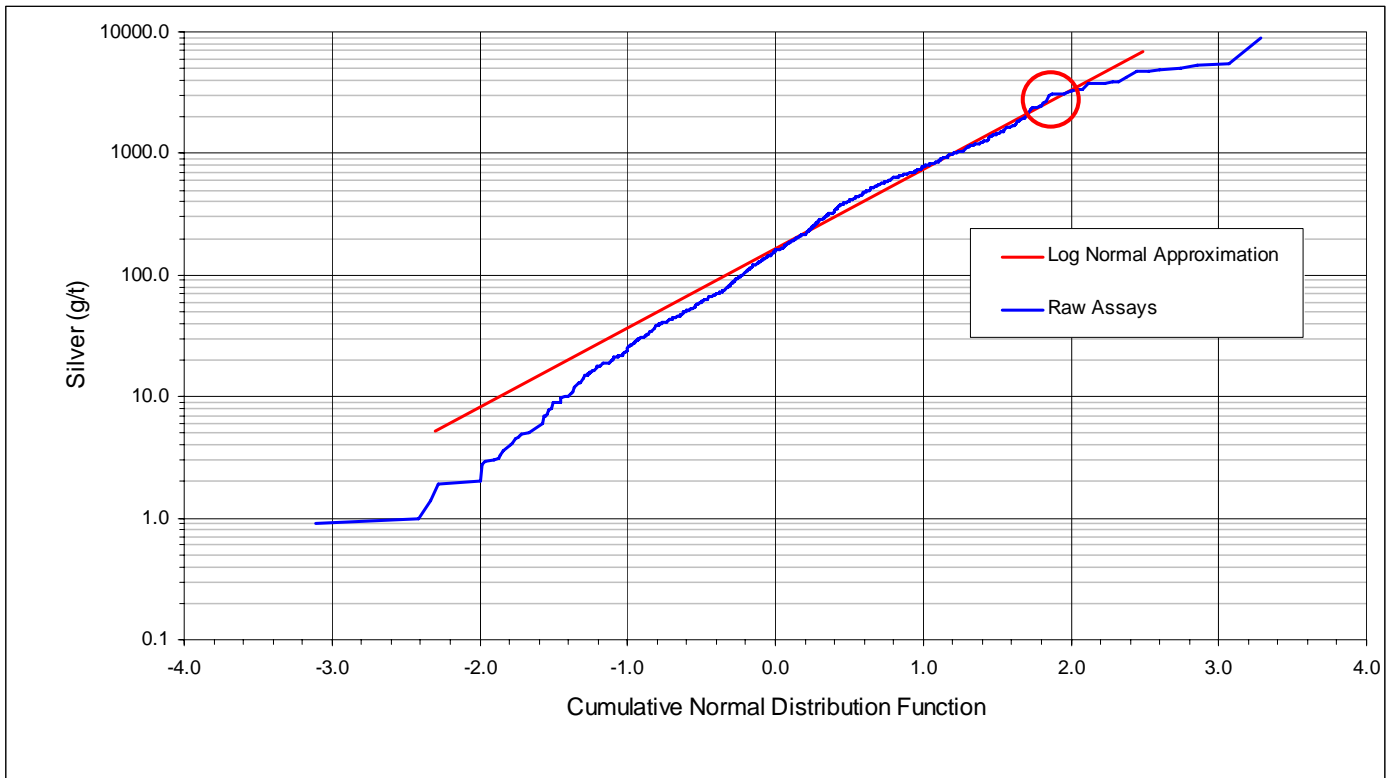

The decile table that was generated for Ayelén silver assays suggests a higher capping limit than the cumulative probability plot shown in Figure 17-4.

Table 17-12: Ayelén Ag Decile Distribution

<i>Decile</i>	<i>No. Samples</i>	<i>Min Grade</i>	<i>Mean Grade</i>	<i>Max Grade</i>	<i>GxT Product</i>	<i>% of Total</i>
0 - 10	81	0.9	6.7	15.4	447	0.15
10 - 20	81	15.5	24.7	37.0	1,631	0.55
20 - 30	81	37.0	47.4	59.7	3,159	1.07
30 - 40	81	60.7	79.3	106.0	5,788	1.96
40 - 50	81	108.0	140.5	173.8	9,617	3.25
50 - 60	81	174.0	224.2	290.0	14,049	4.75
60 - 70	81	290.0	384.1	488.0	26,768	9.05
70 - 80	81	488.0	597.0	689.0	34,531	11.68
80 - 90	81	693.0	908.6	1188.0	54,653	18.48
90 - 100	81	1200.0	2592.5	8910.0	145,053	49.06

Total	810	0.9	457.2	8910.0	295,695	100.00
--------------	------------	------------	--------------	---------------	----------------	---------------

90 - 91	8	1200.0	1243.5	1280.0	8,219	2.78
91 - 92	8	1295.0	1379.6	1413.0	7,312	2.47
92 - 93	8	1450.0	1486.6	1523.0	6,095	2.06
93 - 94	8	1545.0	1652.7	1699.0	9,470	3.20
94 - 95	8	1740.0	1890.2	2043.0	9,791	3.31
95 - 96	8	2113.0	2334.3	2403.0	10,061	3.40
96 - 97	8	2431.0	2638.8	2964.0	10,898	3.69
97 - 98	8	3083.0	3189.8	3339.0	23,700	8.02
98 - 99	8	3410.0	3725.0	3854.0	21,941	7.42
99 - 100	9	3940.0	5167.2	8910.0	37,565	12.70

Sub-total	81	1200.0	2592.5	8910.0	145,053	49.06
------------------	-----------	---------------	---------------	---------------	----------------	--------------

Based on the distribution of Ayelén silver grades, a capping limit of about 3800 g/t is suggested. The cumulative probability plot shown in Figure 17-4 displays some erratic behavior between 2000 and 3000 g/t.

The author elected to cap Ayelén silver assays at 2400 g/t based on the cumulative probability plot shown in Figure 17-4. Table 17-13 summarizes the gold and silver capping limits that were used for the Ayelén and Inéz veins.

Table 17-13: Capping Limits

Vein	Capping Limits (g/t)	
	Gold	Silver
Ayelén	130	2400
Iné	15	600

17.7 Compositing

The drill hole assays were composited using MineSight® software. Approximately one third of the raw assay intervals were less than 1.0-meter in length, a third exactly 1.0-meter in length, and another third greater than 1.0-meter in length. RMI composited the raw assays into one-meter-long intervals based on vein codes that were assigned to the raw assays. Residual sample lengths up to 0.51 meters long were added to the last composite in each hole to avoid using short composites in the estimation process.

Unassayed intervals were set to zero grade prior to compositing the assay data. This assured that each bore hole was composited from top to bottom. Nearly all of the logged vein lithologies were assayed so very little artificial dilution was incurred by setting unassayed intervals to zero grade. Uncapped and capped assay grades were composited so that various grade models could be estimated to determine the actual effect of grade capping.

17.8 Vein Wireframe Construction

RMI constructed three-dimensional wireframe solids using MineSight® software. Vein codes of 10 through 20 were assigned to drill hole assay intervals based on the following information: 1) a nominal gold cutoff grade of 0.50 g/t 2) drill hole logging and 2) Ken Konkin's geologic interpretation. The main Ayelén vein was assigned a mineral zone (MZONE) code of 10 while various hangingwall and footwall splays of the main Ayelén vein were assigned codes 11 through 16. The Inéz vein (located east of the Ayelén vein) was assigned a MZONE code of 20.

Gold and silver grades are noticeably higher near the upper portions of the deposit and clearly decrease with depth. RMI chose to extend the vein wireframes approximately 30 meters beyond the lowest drill hole intercepts based on logged vein lithologies despite the fact that many of the assayed intervals were below the 0.50 g/t cutoff grade. The lower grades from these intercepts helped to establish the base of the mineralized system in the grade estimation plan (Section 17.11).

The XYZ drill hole coordinates for the hangingwall and footwall pierce points for each vein were used to develop those respective surfaces. RMI also digitized poly line strings between drill hole "fences" to provide additional control in constructing the hangingwall and footwall surfaces. A three-dimensional "band" was constructed that merged the hangingwall and footwall surfaces into a cohesive solid. Table 17-14 tabulates the volume and tonnage for each of the modeled wireframes. A bulk density of 2.61 g/cm³ was used to calculate tonnes.

RMI constructed a three-dimensional wireframe which represents an intrusive dyke that is located along the western side of the Ayelén vein using logged lithologic codes. Locally this dyke cross-cuts and disrupts the Ayelén vein. The dyke wireframe was intersected with the Ayelén vein solid resulting in a finalized vein wireframe.

Table 17-14: Wireframe Volumes

MZONE Code	Description	Final Wireframes	
		Volume (m ³)	Tonnes
10	Main Ayelén	281,266	734,103
11	Ayelén HW	64,473	168,273
12	Ayelén HW	805	2,100
13	Ayelén FW	7,773	20,287
14	Ayelén HW	739	1,930
15	Ayelén HW	1,847	4,820
16	Ayelén HW	3,455	9,018
20	Inez	52,846	137,929
Total	n/a	413,203	1,078,459

Figure 17-5 is a perspective view showing the two main vein wireframes (i.e. Ayelén and Inéz) looking N30°W.

17.9 High-grade Wireframes

Two near surface high-grade gold/silver zones were identified and modeled as three-dimensional wireframes. The total volume of the two zones is approximately 9,000 m³ or about 23,500 tonnes. Each high-grade zone was based on both surface chip-channel samples and diamond core holes using a nominal gold cutoff grade of 130 g/t.

Model blocks and drill hole composites were coded with these wireframes and used in the grade estimation plan as described in Section 17.11.

Figure 17-5: Perspective View of Ayelén and Inéz Veins

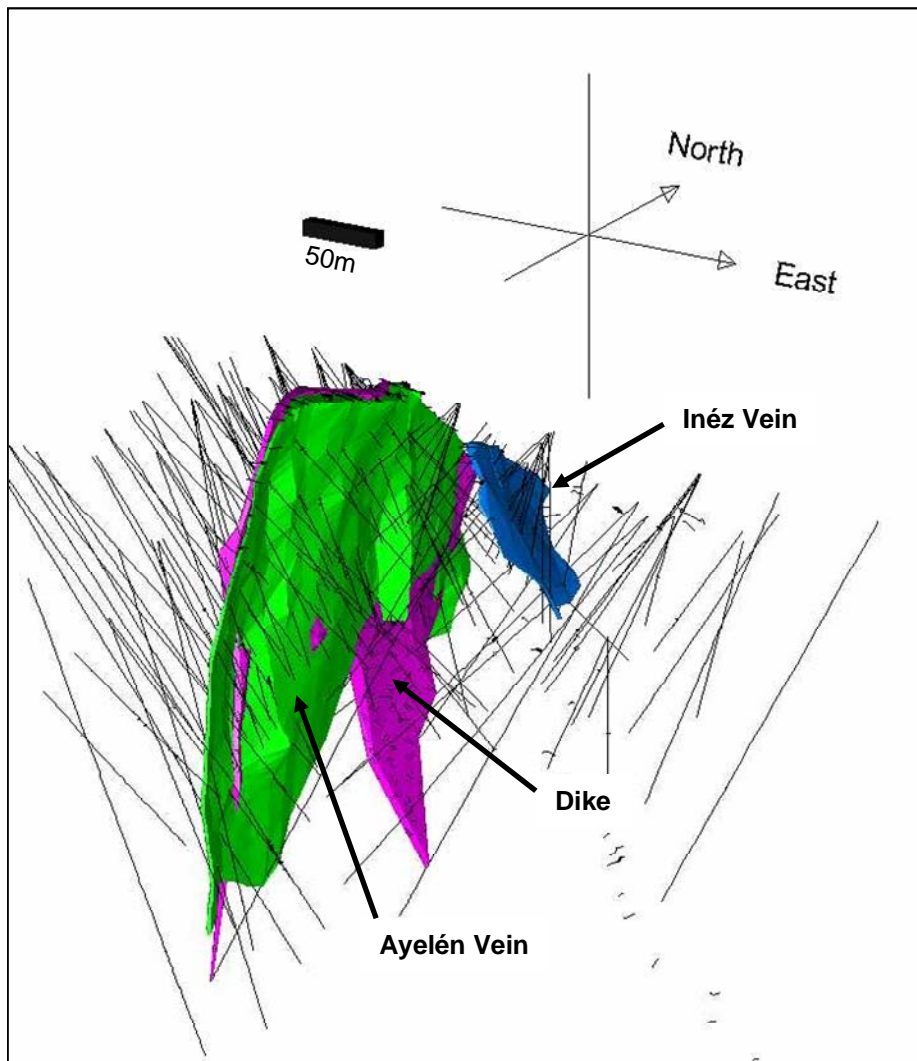

17.10 Variography

The author generated down-hole gold and silver correlograms using uncapped raw assays to establish the nugget effect for each metal. These correlograms showed ranges of about 6.5 meters as illustrated in Figures 17-5 and 17-6 with nuggets of 0.45 and 0.40 for gold and silver respectively.

Directional gold and silver correlograms were generated for the Ayelén vein using one-meter-long composites with Sage2001 software. All 37 correlograms were modeled using Sage's autofit function. These gold and silver directional correlograms are contained in Appendix 1 and 2, respectively.

Figure 17-6: Ayelén Down-hole Gold Correlogram

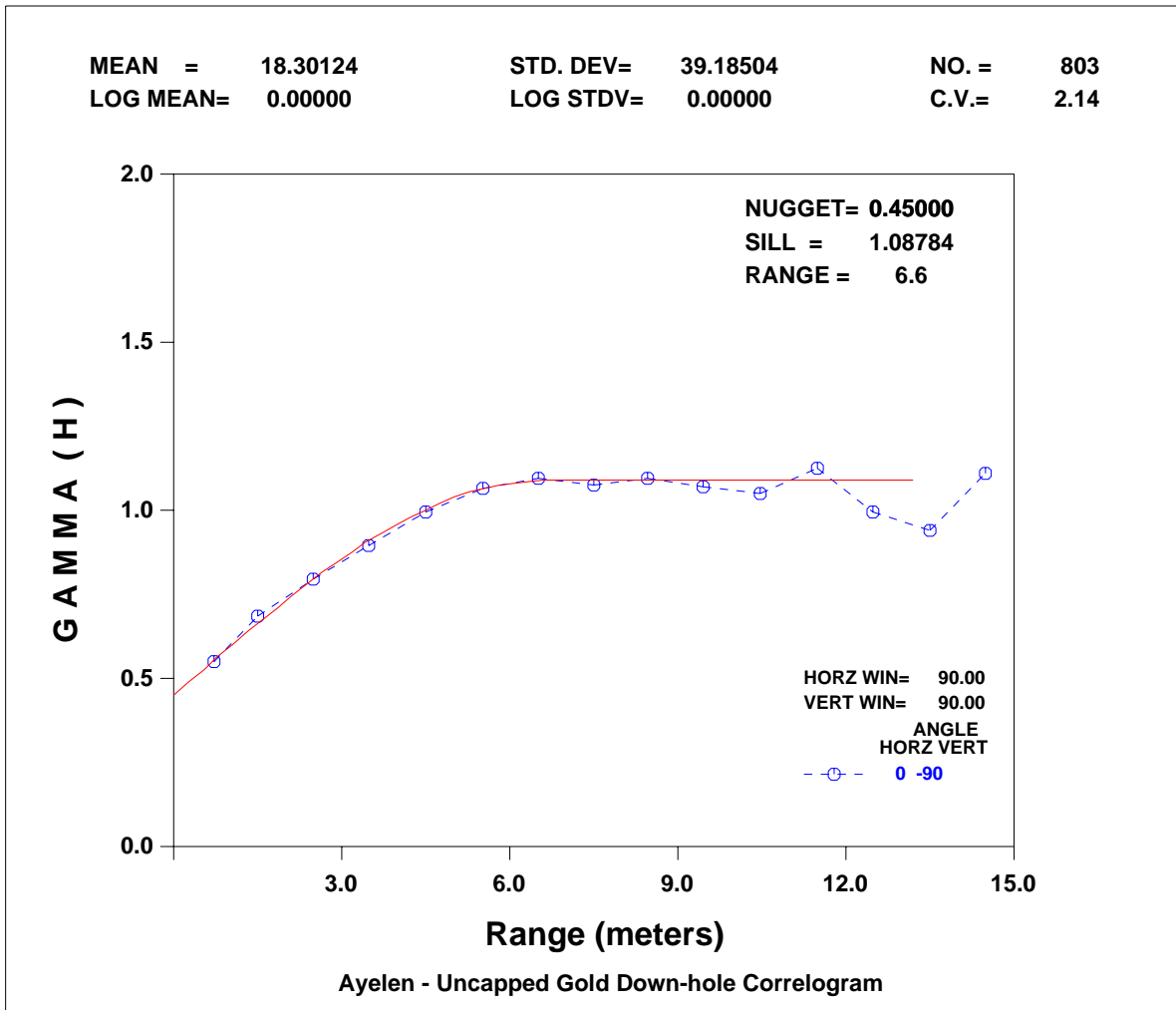
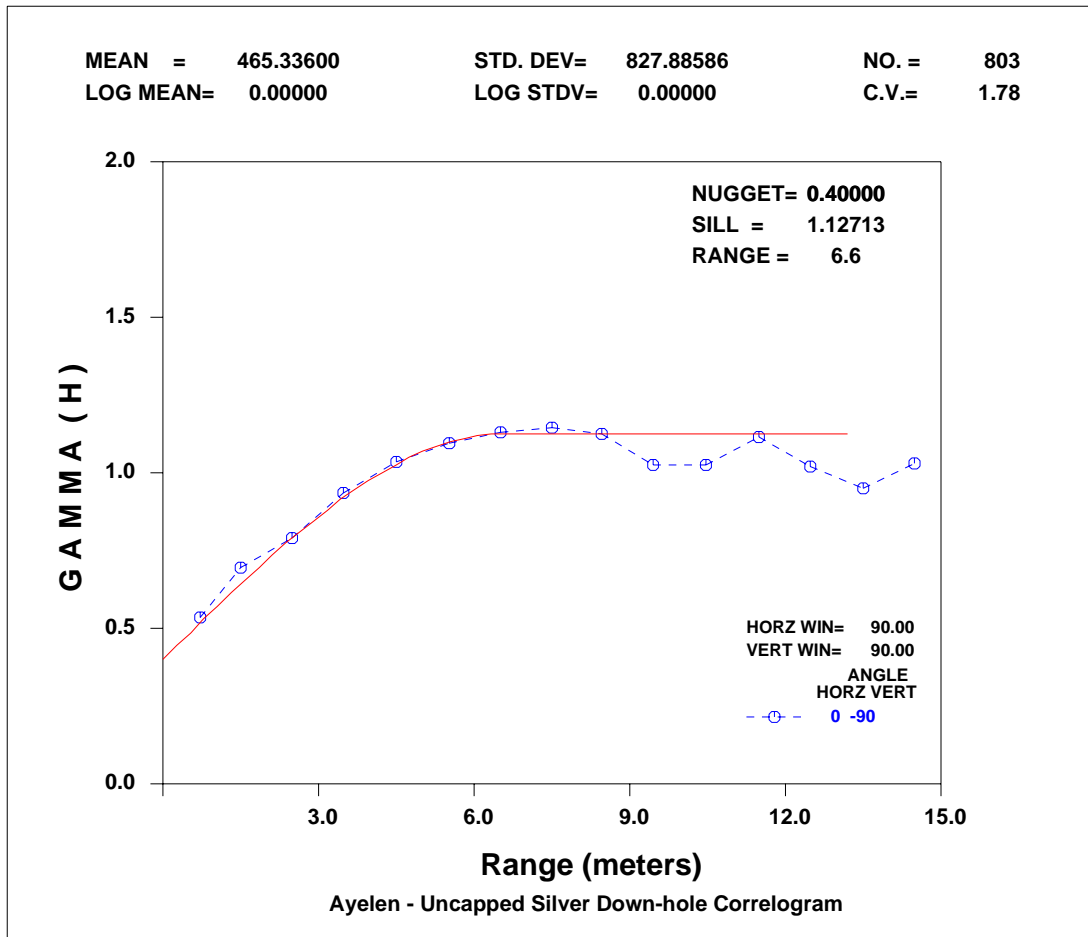

Figure 17-7: Ayelén Down-hole Silver Correlogram



17.11 Grade Estimation

The author constructed a three-dimensional block model using MineSight® software. Table 17-15 summarizes the dimensions and extents of the block model.

Table 17-15: San Luis Block Model Extents

Parameter	Minimum	Maximum	Block Size (m)	Number of Blocks	Areal Extent (m)
Easting	190,300	190,700	1	400	400
Northing	8,960,500	8,961,280	3	260	780
Elevation	4,275	4,600	5	65	325

The vein wireframes (Section 17.8) were used to code the model blocks with an integer code that identified the various veins along with the percentage of the vein contained in each block. This allowed for a more accurate estimate of vein tonnage than

whole or sub-blocking methods. The percentage of “topo” or rock contained in each block was also calculated and stored in the model.

Gold and silver grades were estimated using several techniques including inverse distance estimation, ordinary kriging, and nearest neighbor methods. RMI used a dynamic anisotropy method for determining which composites were used to estimate block grades. Prior to estimating metal grades, the perpendicular distance between each block and the Ayelén hangingwall and footwall surfaces were calculated and stored in the model. Those distances were then backtagged to the drill hole composites. The distance between each block and the vein contact was used to match composites located at similar distances from the vein for the purpose of estimating gold and silver grades using a three-pass inverse distance interpolation plan that used progressively longer search distances to find eligible composites. If a block was located closer to the hangingwall contact of the vein, only composites located at similar distances from the hangingwall contact were used to estimate block grades. The same function was used for blocks located near the footwall contact.

Block gold and silver grades were estimated using composites derived from capped raw assays. Uncapped grades were used to estimate block grades inside of the two high-grade zones that were described in Section 17.9. The two high-grade zones with mineral zone 10 represent about three percent of the total volume of that zone.

Table 17-16 summarizes the basic inverse distance cubed parameters that were used to estimate gold and silver grades for the main Ayelén vein (MZONE 10).

Table 17-16: Inverse Distance Grade Estimation Parameters

Estimation Pass	Composite Selection			Search Distance (m)		
	Min	Max	Max/hole	Along Strike	Down-dip	Across Strike
1	1	3	1	12.5	12.5	Variable ¹
2	1	3	1	37.5	37.5	Variable ¹
3	1	3	1	75.0	75.0	Variable ¹

¹ For the main Ayelén vein (MZONE = 10) the cross strike distance for accepting composites was a function of the block/composite distances from either the footwall or hangingwall vein surface. For all other veins a strict matching method was used based on MZONE codes. The cross strike search distance was essentially limited to the width of the vein wireframe.

The same three pass inverse distance cubed estimation strategy was used to estimate gold and silver grades for the remaining Ayelén and Inéz veins (MZONE 11 through 20). The number of composites and drill holes used to estimate block grades was captured along with the Cartesian distance to the closest composite used in the estimation process.

Approximately 37% of the blocks were estimated by the first pass (12.5m search), 58% by the second pass (37.5m search), and the remaining 5% of the estimated blocks by the longer 75-meter search.

17.12 Model Verification

Block grades were validated by both visual and statistical methods. RMI notes that the dynamic anisotropy method resulted in generating a distribution of metal grades which is similar to the observed distribution of high-grade ore shoots and internal waste selvages that are commonly observed in epithermal precious metal vein deposits. For example, Figure 17-8 and 17-9 show block gold grade contours for cross section 8,960,885 north and the 4530 bench elevation, respectively, which show feathery zones of various grade ranges.

Figure 17-8: Block Au Grade Contours – Section 8,960,885 North

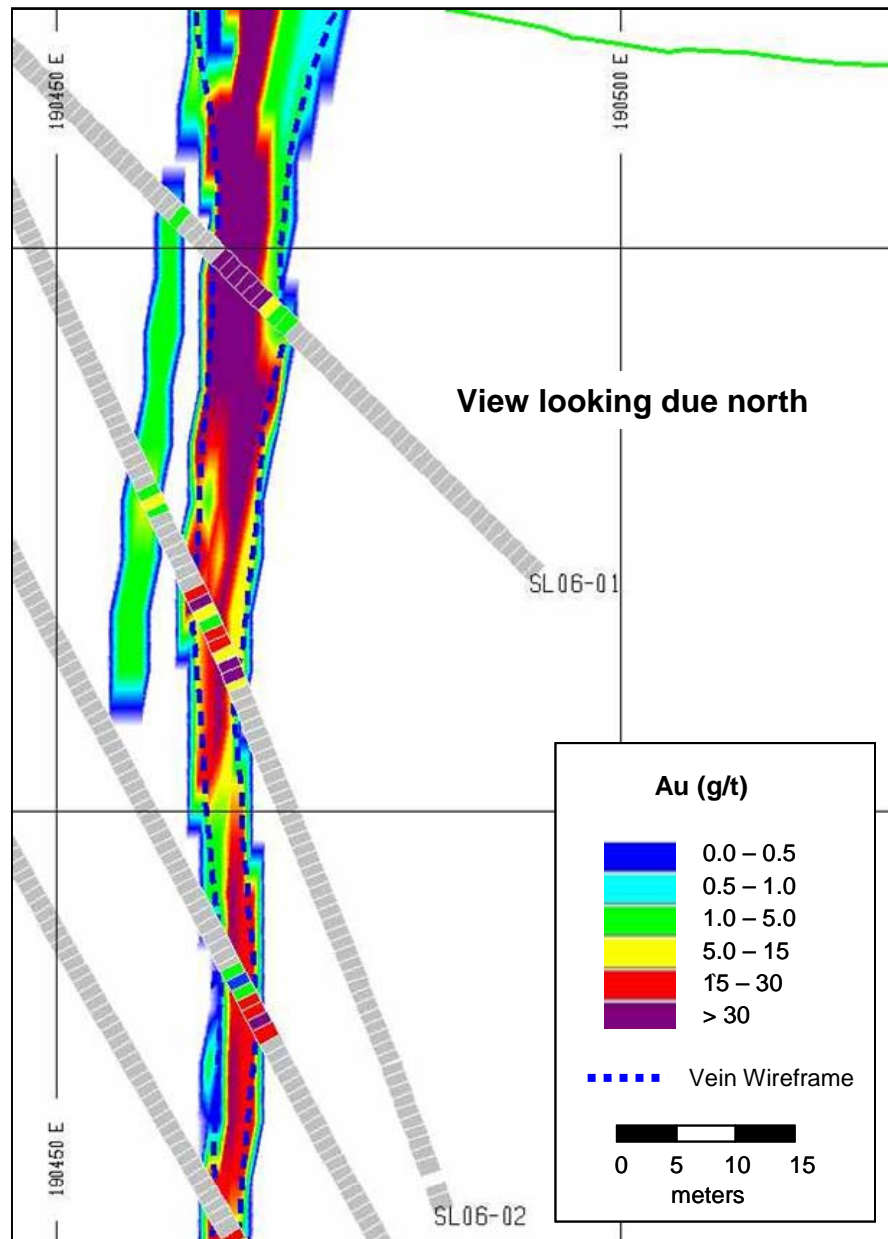

Block model gold and silver grade cross sections are located in Appendices 3 and 4, respectively. Similarly, estimated block gold and silver grade level plans are found in Appendices 5 and 6, respectively.

Figure 17-9: Block Au Grade Contours – 4530 Elevation

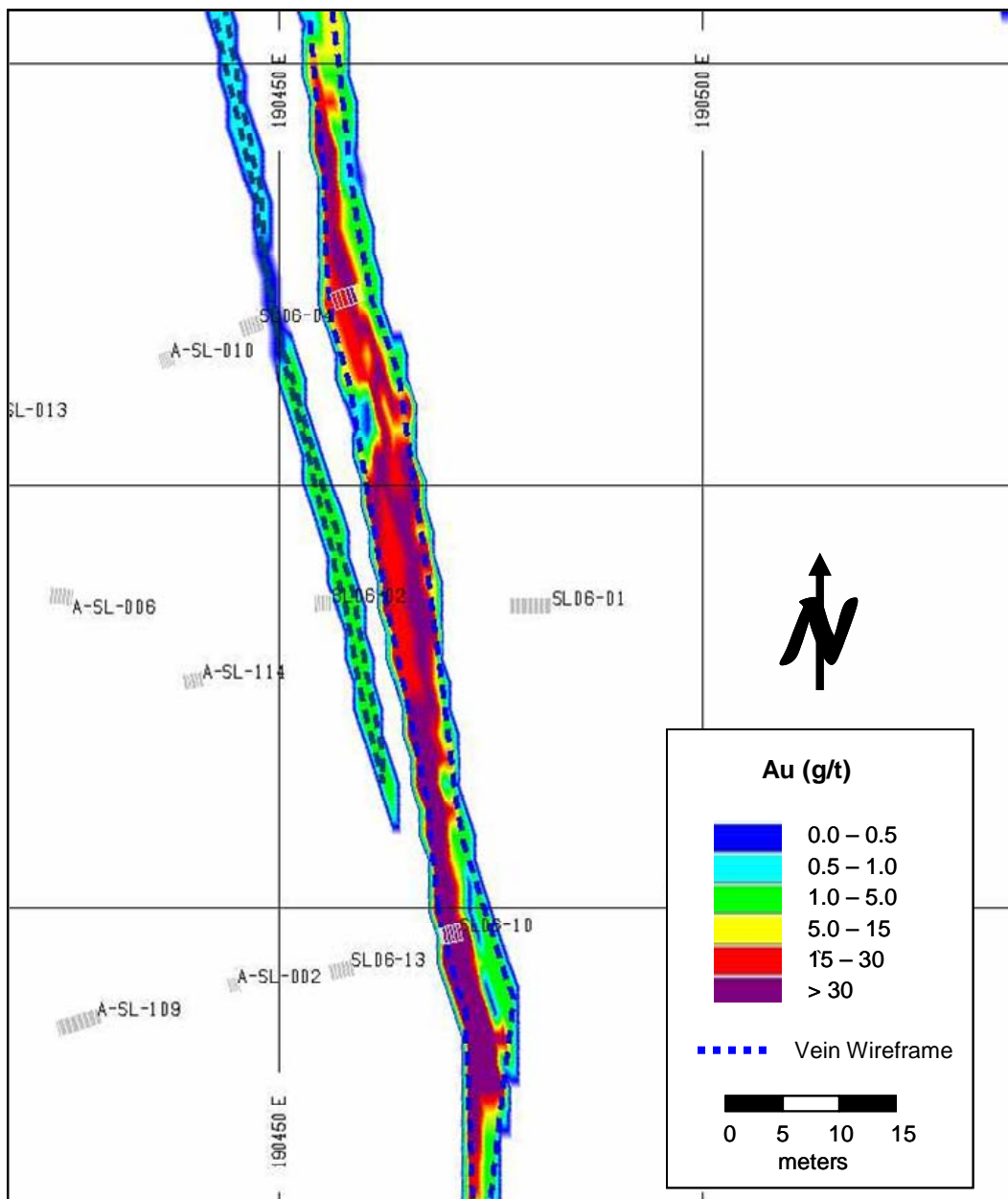

The distribution or frequency of drill hole composite grades versus estimated block grades was compared. The composites were declustered using the cell method (1m x 3m x 5m). Figures 17-10 through 17-13 show histogram and cumulative probability plots that compare declustered composites versus block grades. The composite and block grades were transformed using the cumulative normal distribution function. This comparison was made for all vein composites and all estimated blocks regardless of resource category.

Figure 17-10: Au Composite vs. Au Block Histogram

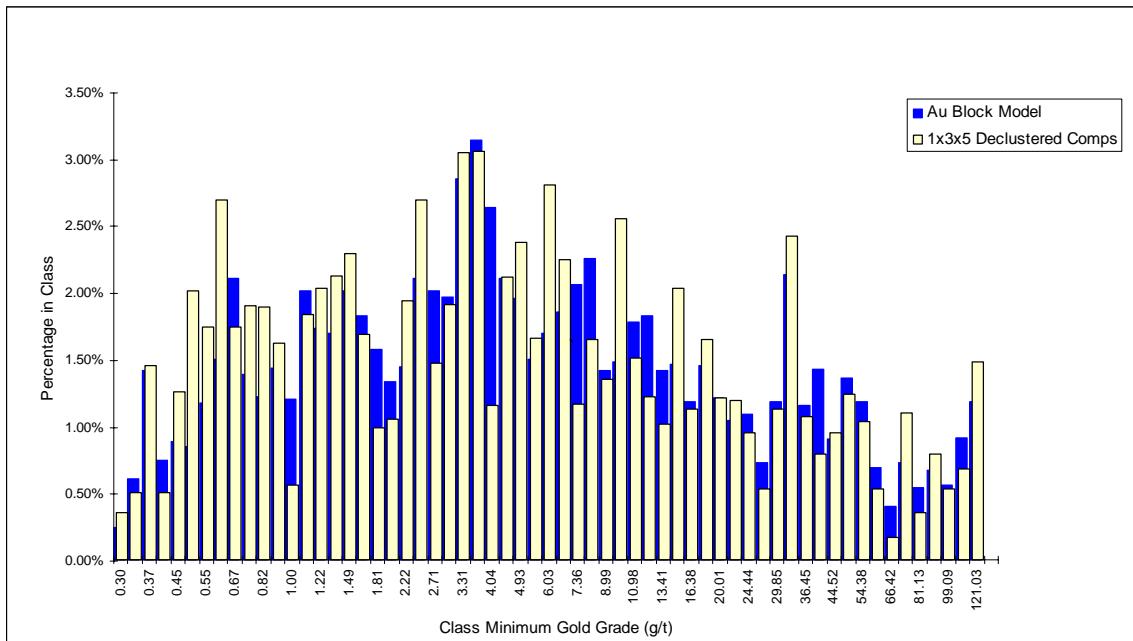

There are some mid-grade ranges where the composite frequency is 0.5 to 1.0 percent lower than the estimated block grades. RMI attributes this to a relatively limited number of drill hole composites.

Figure 17-11: Au Composite vs. Au Block Grades

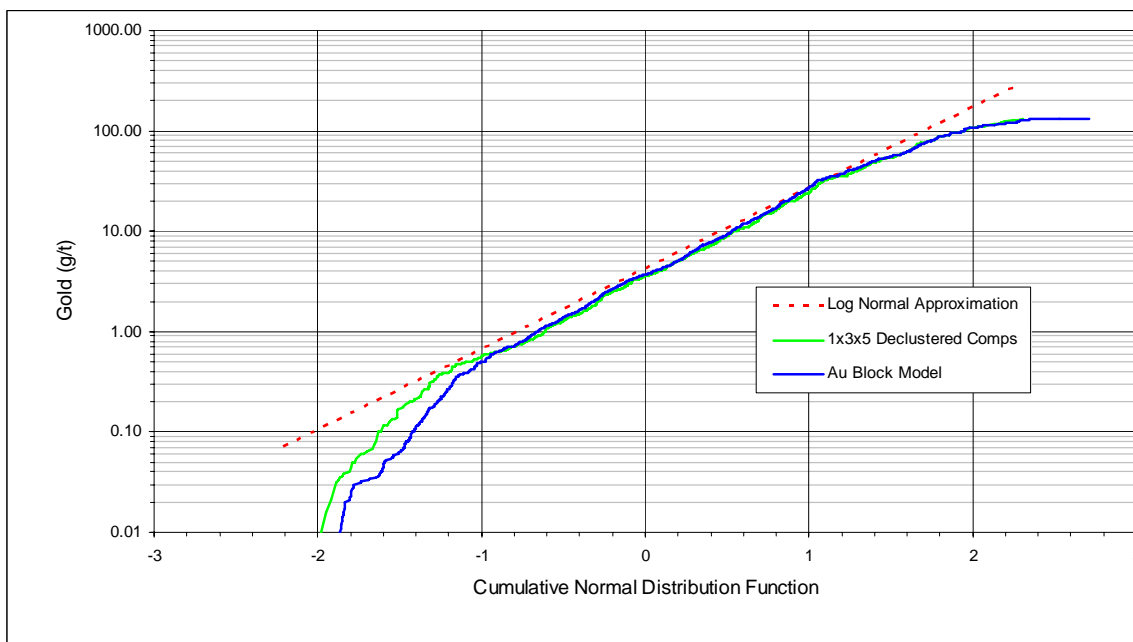
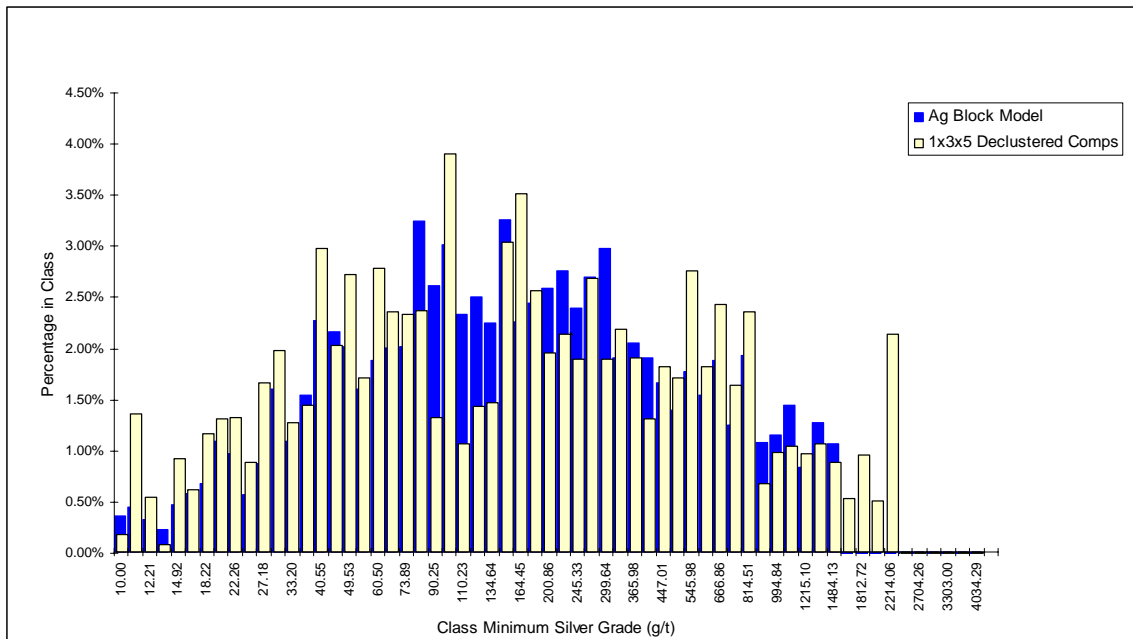
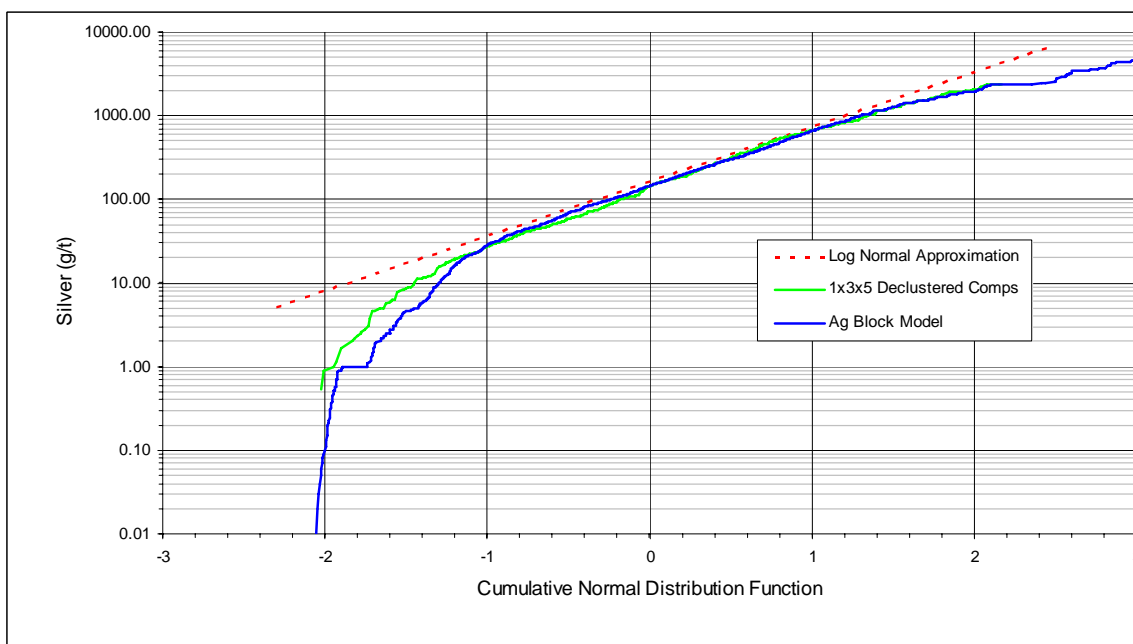

Figure 17-12: Ag Composite vs. Ag Block Histogram



Similar to the gold histogram (Figure 17-10), the silver composites are also up to 1% lower in frequency than the estimated block grades as shown in the grade range of 100 and 130 g/t.

Figure 17-13: Ag Composite vs. Ag Block Grades



The gold and silver grades shown in the cumulative probability plots (Figures 17-11 and 17-13, respectively) show a very close relationship except at the very low grade range.

Based on visual and statistical comparisons, it is RMI's opinion that the estimated block gold and silver grades are reasonable and honor the sample data.

17.13 Resource Classification

The estimated block grades were classified into Measured, Indicated, and Inferred categories using the distance to data method. Measured Mineral Resources were only assigned to blocks within 15 meters of surface trenching along the Ayelén vein. The rationale for this assignment is that the continuity of the mineralized system was both visually and analytically confirmed by mapping and assaying. Blocks within 15 meters of trenching data along the Inéz vein were classified as Indicated Resources because of less confidence in the continuity of grade within this vein. The remainder of the estimated Inéz blocks were classified as Inferred Mineral Resources. Ayelén vein blocks within 25 meters of sample data (primarily diamond core samples) were classified as Indicated Mineral Resources. The remainder of the estimated Ayelén blocks that were not classified as either Measured or Indicated Mineral Resources were classified as Inferred Resources.

17.14 Mineral Resource Tabulation

Mineral Resources were tabulated using a 6.0 g/t gold equivalent cutoff grade. Gold and silver metal prices of US\$600 and US\$9.25 per troy ounce were used to establish a gold to silver ratio of 65:1. No metal recoveries were used. Table 17-17 shows the combined Ayelén and Inéz Mineral Resources.

Table 17-17: San Luis Mineral Resources

Measured Mineral Resources						
Tonnes	Au (g/t)	Ag (g/t)	AuEQV (g/t)	Contained Au Ounces	Contained Ag Ounces	Contained AuEQV Ounces
55,000	34.3	757.6	46.0	61,000	1,345,100	81,700
Indicated Mineral Resources						
Tonnes	Au (g/t)	Ag (g/t)	AuEQV (g/t)	Au Ounces	Ag Ounces	AuEQV Ounces
429,000	20.8	555.0	29.3	287,000	7,658,200	404,800
Measured and Indicated Mineral Resources						
Tonnes	Au (g/t)	Ag (g/t)	AuEQV (g/t)	Au Ounces	Ag Ounces	AuEQV Ounces
484,000	22.4	578.1	31.2	348,100	9,003,300	486,500
Inferred Mineral Resources						
Tonnes	Au (g/t)	Ag (g/t)	AuEQV (g/t)	Au Ounces	Ag Ounces	AuEQV Ounces
20,000	5.6	270.1	9.7	3,600	174,900	6,300

In a previous NI 43-101 report (Blanchflower, 2007), Mineral Resources were tabulated using a straight silver cutoff grade of 40 g/t. Table 17-18 compares the previously disclosed Mineral Resources with the updated resources that are the subject of this report.

Table 17-18: Mineral Resources Using a 40 g/t Ag Cutoff

2007 Estimate by Category	Tonnes	Au (g/t)	Ag (g/t)	Contained Ounces	
				Au	Ag
Measured + Indicated Resources	673,900	12.2	328.9	265,200	7,126,000
Inferred Resources	14,600	9.3	282.4	4,400	132,000
2008 Estimate by Category					
	Tonnes	Au (g/t)	Ag (g/t)	Contained Ounces	
				Au	Ag
Measured + Indicated Resources	780,000	14.6	393.5	366,100	9,868,000
Inferred Resources	82,000	2.6	133.6	6,900	352,200

18.0 OTHER RELEVANT DATA AND INFORMATION

There are no other relevant data or information pertaining to the update to the San Luis Mineral Resource update that is the focus of this Technical Report.

19.0 INTERPRETATION AND CONCLUSIONS

19.1 Interpretation

The geologic interpretation of the Ayelén and Inéz veins are, In the opinion of REI and RMI, reasonable and valid for use as the three-dimensional geologic framework for the estimation of updated Mineral Resources for these veins.

19.2 Conclusions

In the opinion of REI and RMI, the updated Mineral Resource estimation that is the focus of this Technical Report are based on valid assay data, specific gravity data, lithologic and alteration data, and structural data. These data are supported by a sufficient QA/QC program, such that the resulting updated Mineral Resource estimate is a reasonable estimate of the insitu gold and silver mineralization that could be extracted in the future, given favorable economic conditions. However, it is not certain that any of these Mineral Resources might convert to Proven and Probable Mineral Reserves without additional metallurgical testwork, environmental studies, and economic analyses that include conceptual mine plans and designs, production schedules, detailed operating and capital cost estimates, general and administrative cost estimates, and smelting/refining cost estimates.

20.0 RECOMMENDATIONS

SSRI and Esperanza are currently preparing a feasibility study to address the economic viability of the San Luis project. This study is scheduled to be completed sometime within the first half of 2009. An environmental impact study has been commissioned and is anticipated to be completed near the end of 2009. In addition, the SSRI-Esperanza joint venture is currently negotiating a long term land access agreement.

RMI and REI make the following recommendations:

- There is very little Inferred material within the currently defined Ayelén vein but a significant portion of the Inéz vein is classified as an Inferred Mineral Resource. The joint venture should review whether additional drilling should be completed on the Inéz vein in order to upgrade the Inferred Mineral Resources to Measured or Indicated categories. RMI and REI note that the gold and silver grades within the currently defined Inéz vein are significantly lower than the main Ayelén vein. Similarly, the mineralized continuity of the Inéz vein is not nearly as consistent as the Ayelén vein. The cost for additional drilling is highly variable and depends on the meterage to be drilled.
- The SSRI-Esperanza joint venture should obtain a more accurate topographic base map using traditional aerial survey methods. This is not a particularly material issue regarding ore tonnage estimates for an underground operation but the detailed topographic data will be required for surface construction activities. The cost for obtained detailed topographic information could range between \$50,000 to \$200,000.
- The SSRI-Esperanza joint venture should include a “scoping level-type” study as a part of the ongoing feasibility study to address mining method options. In the opinion of RMI and REI, a significant portion of the deposit may be amenable to open pit mining methods. The cost for such a study could range between \$10,000 and \$50,000.
- Additional metallurgical studies should be completed to determine the preferred processing methods and develop a feasibility-level process flowsheet.

21.0 REFERENCES

Blanchflower J.D., 2007, Technical Report on the San Luis Property, District of Shupluy, Yungay Province, Ancash Department, Peru, Latitude 09° 23' South by Longitude 77° 47' West, Published NI -43101 Report prepared for Silver Standard Resources Inc. and Esperanza Silver Corporation, 213 p.

McCrea, J.A., 2006, San Luis Project, 2006 QA/QC Review of Trench Sample Data, unpublished internal report written for the San Luis Joint Venture, 18 p.

McCrea, J.A., 2007, San Luis Project, 2007 QA/QC Review of Drill Hole Sample Data, unpublished internal report written for the San Luis Joint Venture, 13 p.

Wright, F., 2008, San Luis Gold Silver Project Preliminary Metallurgical Study, Unpublished independent report prepared for Silver Standard Resources, Inc., 33 p.

22.0 DATE AND SIGNATURE PAGE

I, Michael J. Lechner, of Tucson, Arizona do hereby certify:

1. That I am an independent consultant and owner of Resource Modeling Incorporated, an Arizona Corporation with it's office located at 1960 West Muirhead Loop, Tucson, AZ 85737
2. That I am a registered professional geologist in the State of Arizona (#37753) and a Certified Professional Geologist with the AIPG (#10690).
3. That I am a graduate of the University of Montana (1979) with a Bachelor of Arts degree in Geology.
4. That I have practiced my profession continuously since 1977.
5. That I have worked as an exploration geologist, mine geologist, Engineering Superintendent, resource modeler, and consultant on a wide variety of base and precious metal deposits throughout the world.
6. That I, Michael J. Lechner, performed various statistical and geostatistical analyses of the drill hole data and independently estimated gold resources for the San Luis deposit. I'm responsible for all or portions of Sections 14 and 17 of the report titled, "Updated Mineral Resource Estimate, San Luis Project, Ancash Department, Perú" dated January 9, 2009.
7. That as of the date of this certificate, I am not aware of any material fact or material change with regard to the property that would make this report to be misleading.
8. That I have written this report as an independent consulting geologist and have no material interest, direct or indirect, in the property discussed in this report and have not had any prior involvement with this property prior to working with Silver Standard Resources and Esperanza Silver.
9. I have read NI 43-101 and fully believe that this report has been written in complete compliance with that Instrument.
10. I am independent of Silver Standard Resources Inc. and Esperanza Silver Corporation, applying all of the tests in Section 1.5 of National Instrument 43-101.

I, Donald F. Earnest, P.G. do hereby certify that:

1. I am a Mining Geologist and President of Resource Evaluation Inc., residing at 11830 N. Joi Drive, Tucson, Arizona 85737 USA.
2. I am a graduate with a Bachelor of Science, Geology degree from The Ohio State University, 1973.
3. I am a Registered Professional Geologist (P.G.) in the States of Arizona (#36976) and Idaho (#746), and a member of the Society of Mining Engineers (SME).
4. I have 35 years experience in mining and exploration geology, mineral resource and mineral reserve estimation, mine management, and consulting, which includes over 20 years directly related to vein-hosted precious metal deposits.
5. I have read the definition of “qualified person” set out in National Instrument 43-101 (“NI 43-101”) and certify that by reason of my education and professional registration (as defined in NI 43-101) and past relevant work experience, I fulfill the requirements to be a “qualified person” for the purposes of NI 43-101.
6. I am responsible for preparation of all or portions of Sections 1.0, 2.0, 3.0, 4.0, 5.0, 6.0, 7.0, 8.0, 9.0, 10.0, 11.0, 12.0, 13.0, 14.0, 15.0, 16.0, and 18.0 of the report titled, “Updated Mineral Resource Estimate, San Luis Project, Ancash Department, Perú” dated January 9, 2009. I visited the San Luis project site on June 25 and 26, 2009.
7. I have not had prior involvement with the San Luis project that is the subject of the Technical Report.
8. I am not aware of any material fact or material change with respect to the subject matter of the Technical Report that is not reflected in the Technical Report, the omission to disclose which would make the Technical Report misleading.
9. I am independent of Silver Standard Resources Inc. and Esperanza Silver Corporation, applying all of the tests in Section 1.5 of National Instrument 43-101.

**23.0 ADDITIONAL REQUIREMENTS FOR TECHNICAL REPORTS ON
DEVELOPMENT PROPERTIES AND PRODUCTION PROPERTIES**

There are no additional requirements for this project.

**Updated Mineral Resource Estimate San Luis Project,
Ancash Department, Perú
January 9, 2009**

APPENDIX 1: Gold Correlograms

Ayelen Vein - AUCAP Correlograms

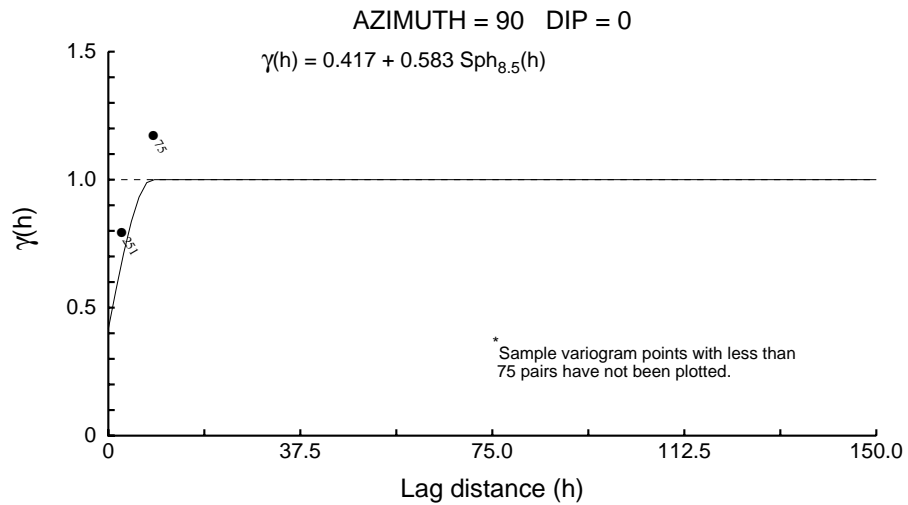
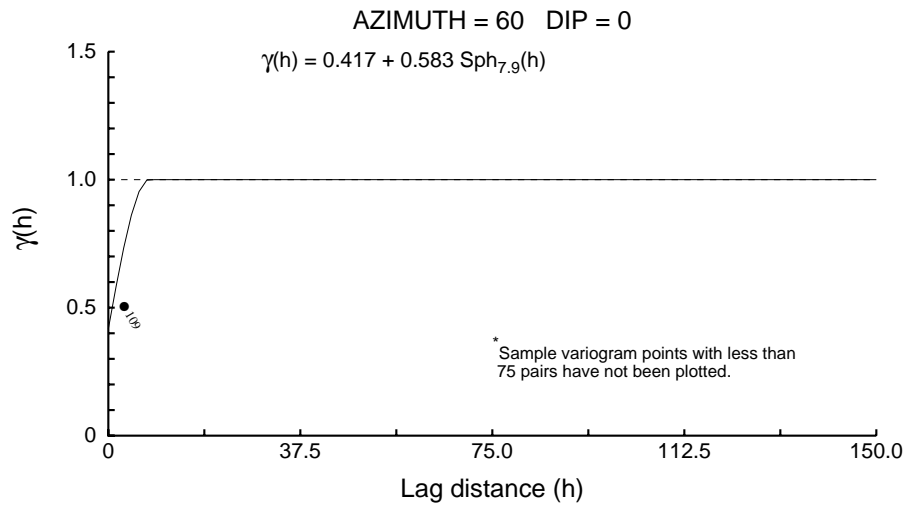
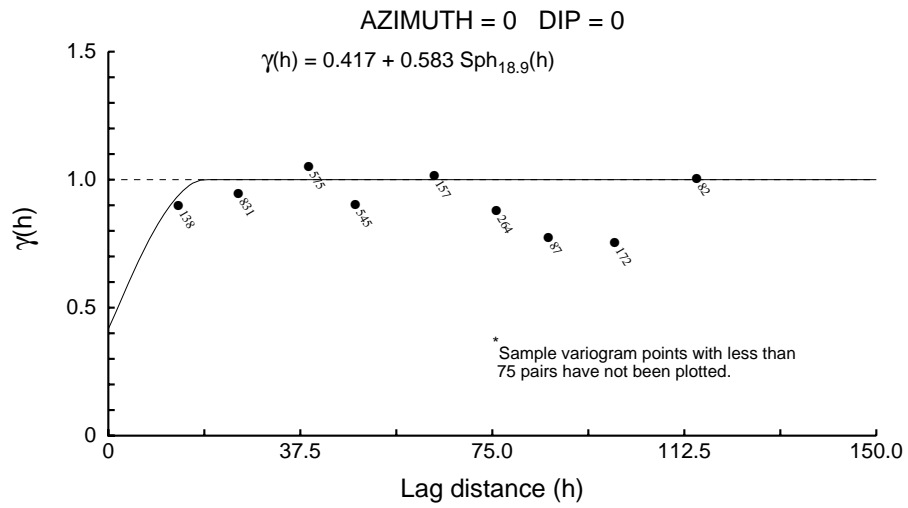

Ayelen Vein - AUCAP Correlograms

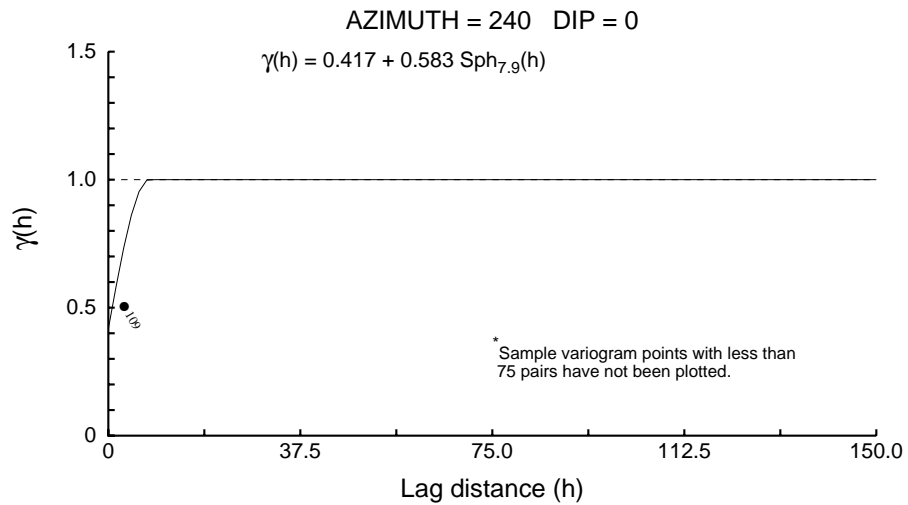
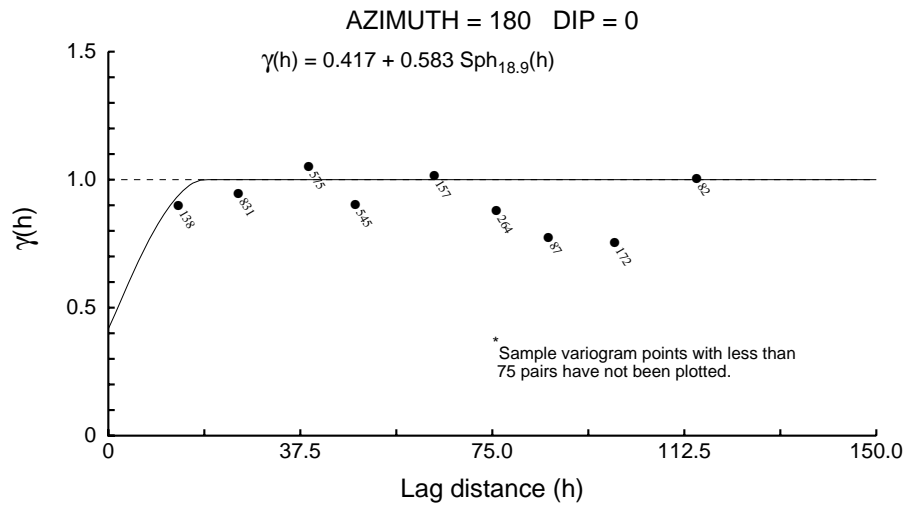
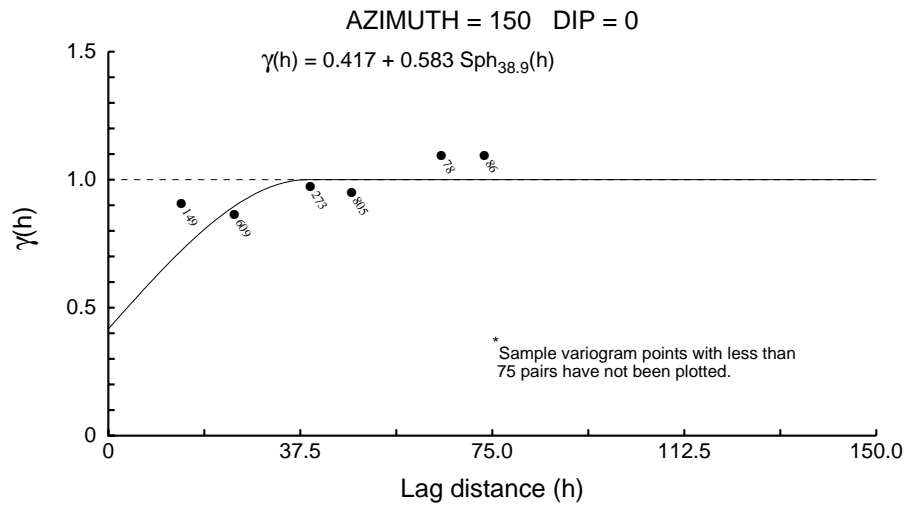

Ayelen Vein - AUCAP Correlograms

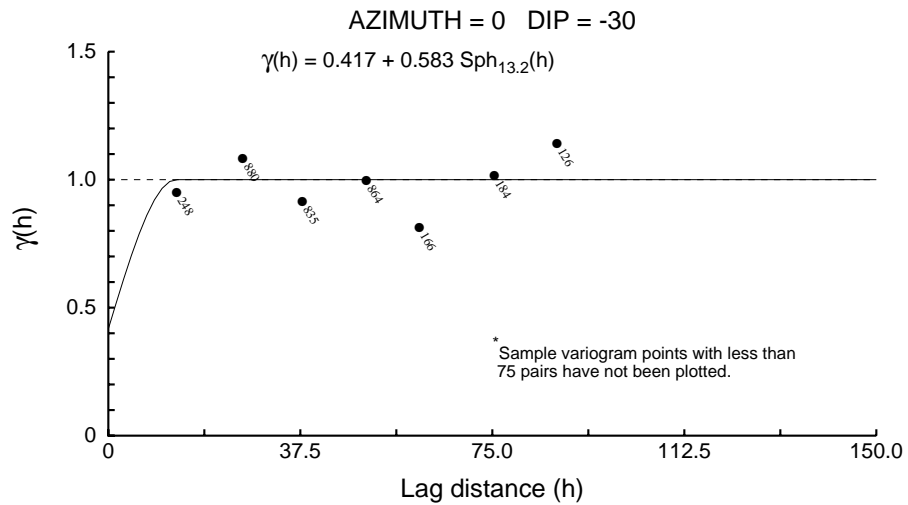
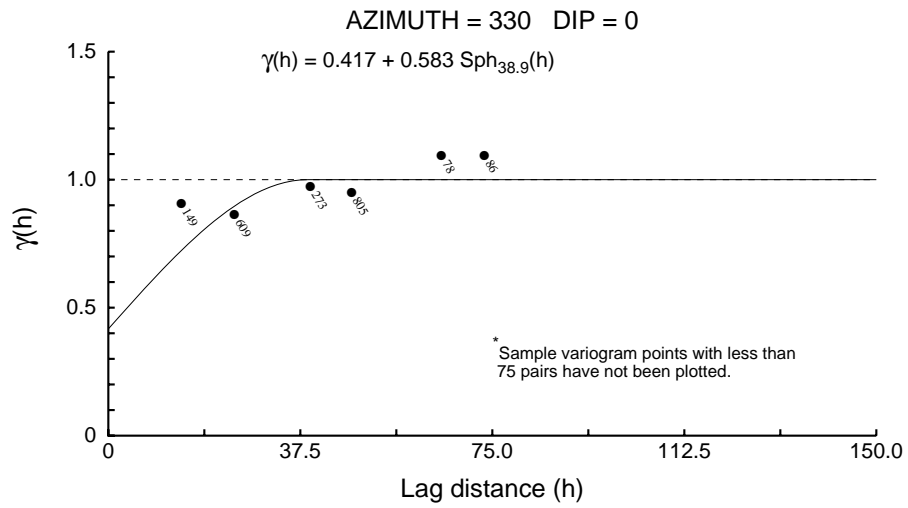
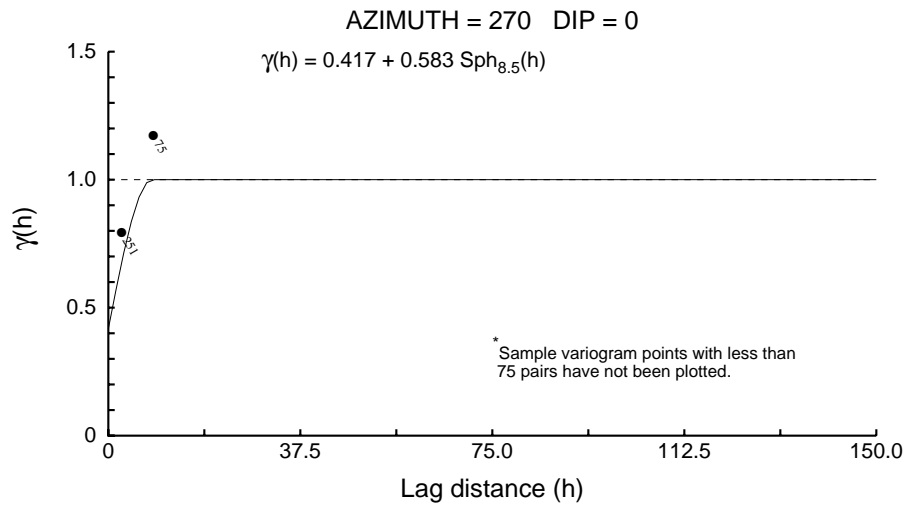

Ayelen Vein - AUCAP Correlograms

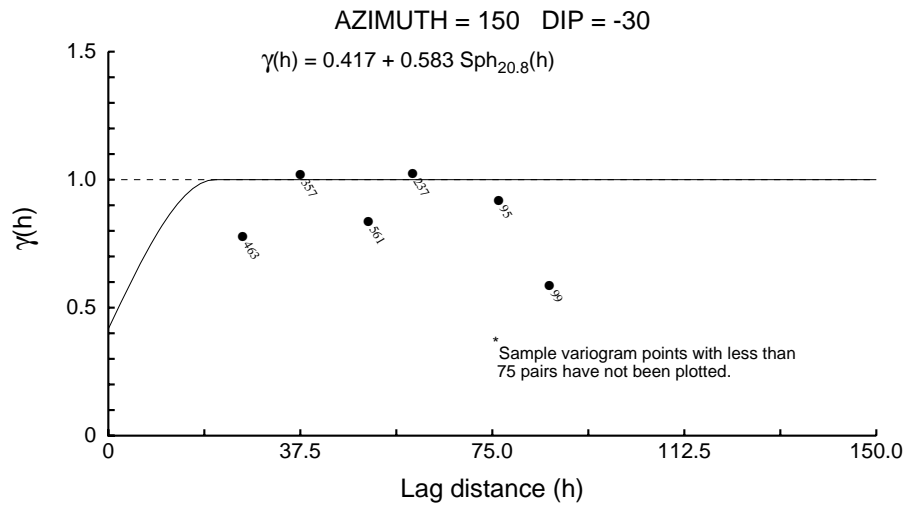
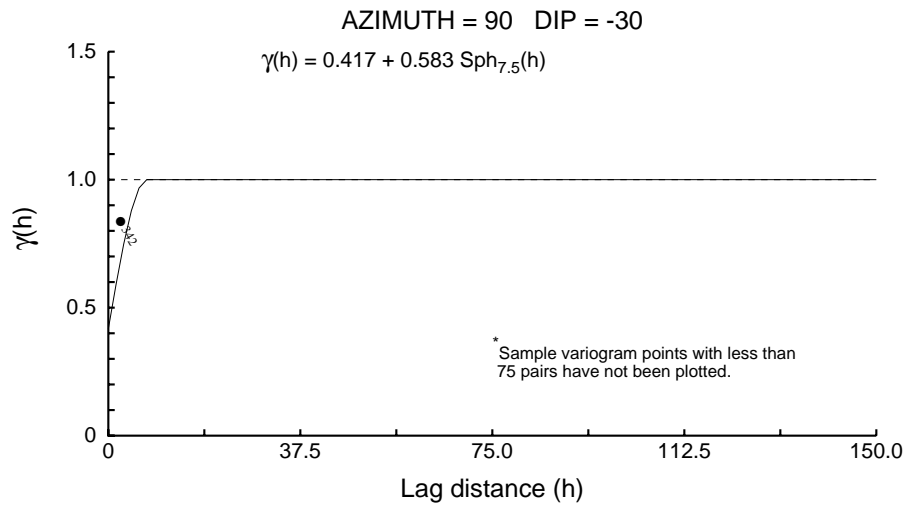
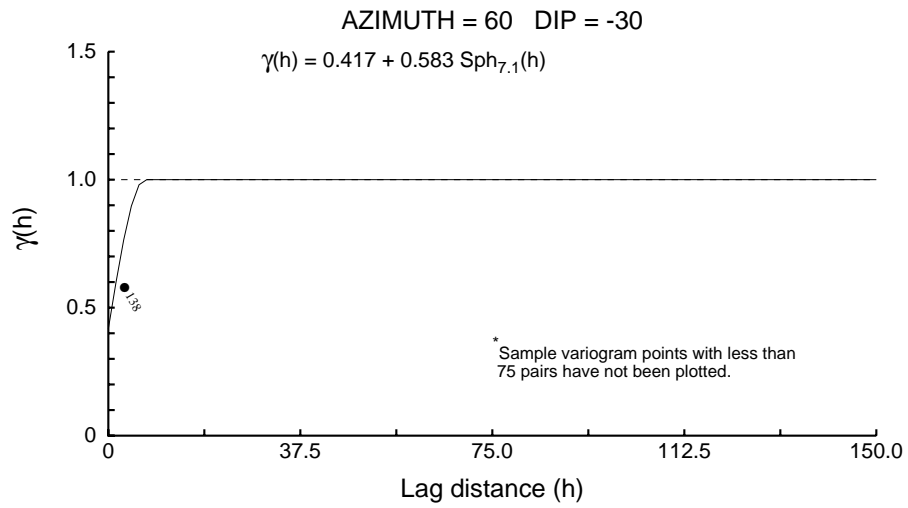

Ayelen Vein - AUCAP Correlograms

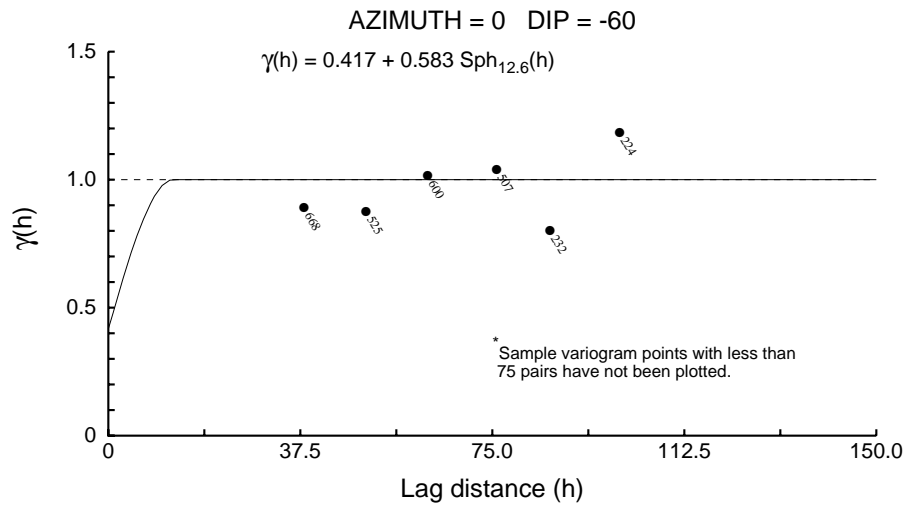
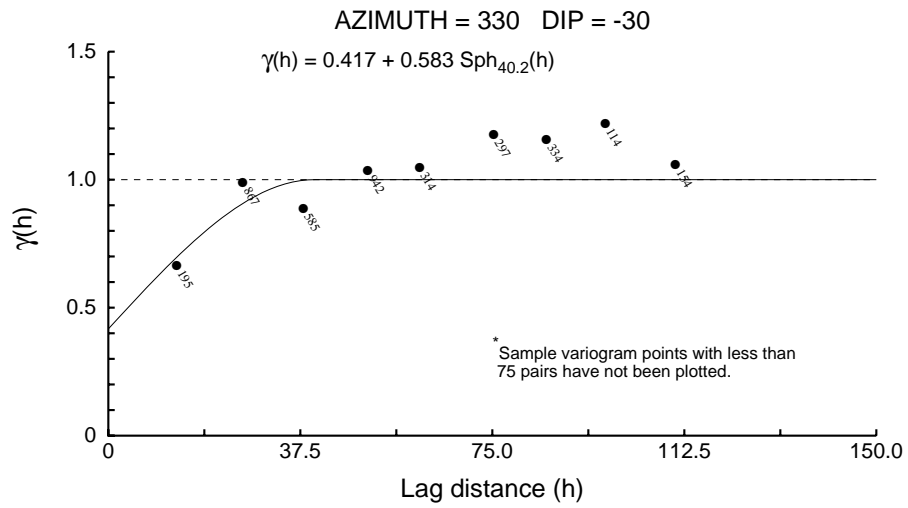
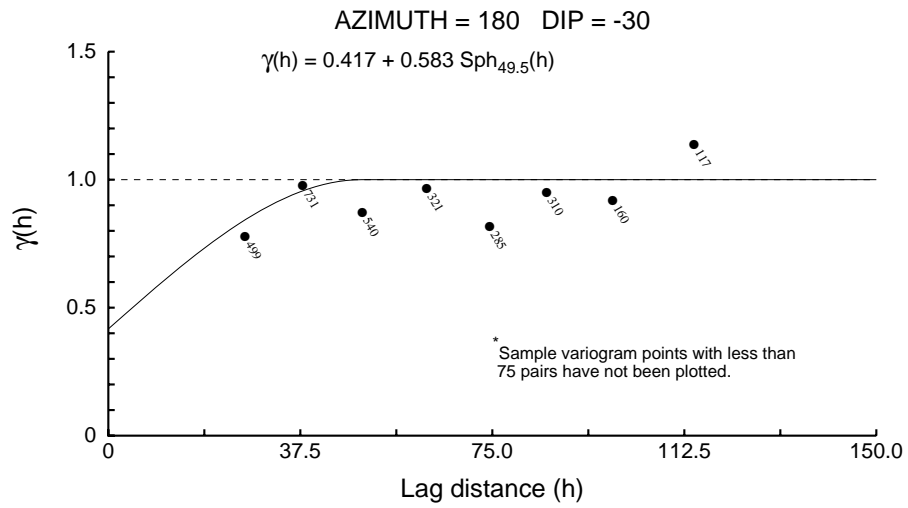

Ayelen Vein - AUCAP Correlograms

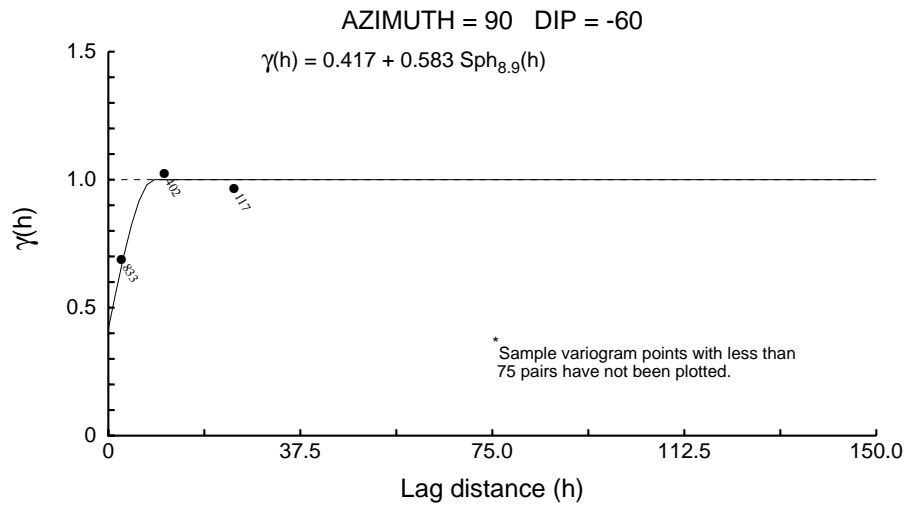
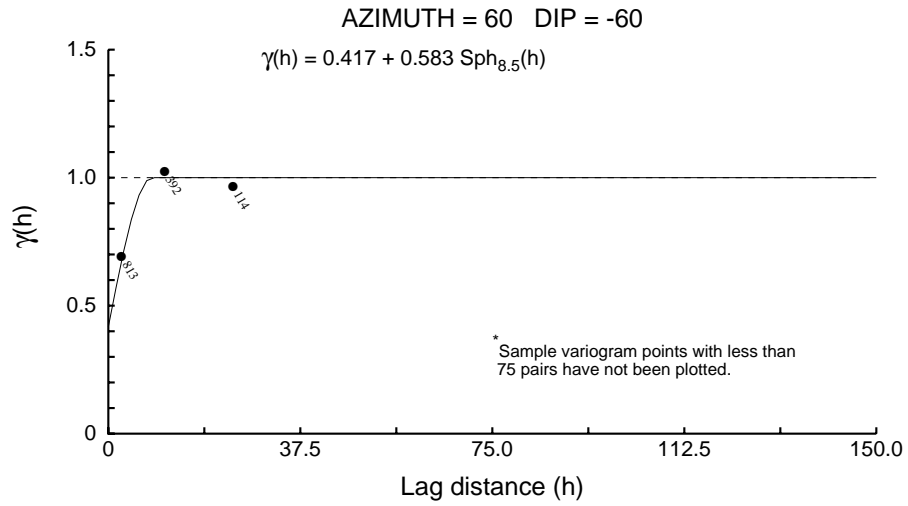
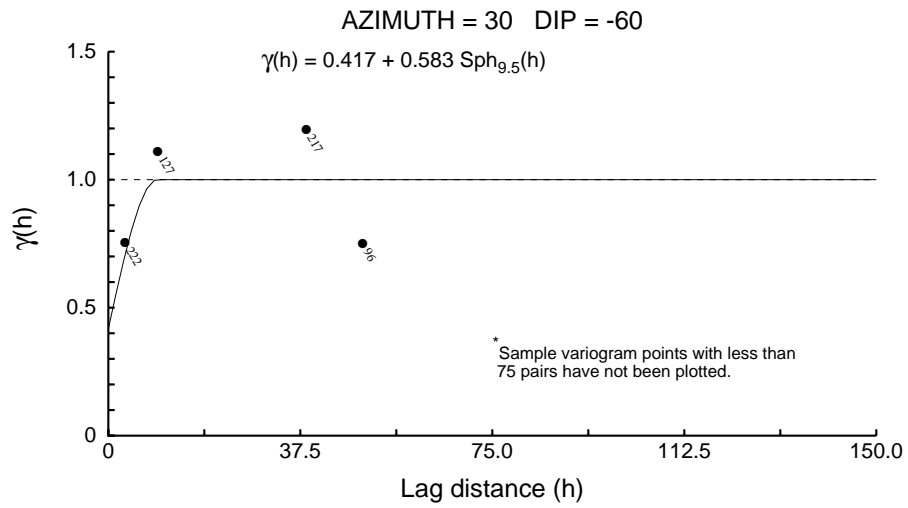

Ayelen Vein - AUCAP Correlograms

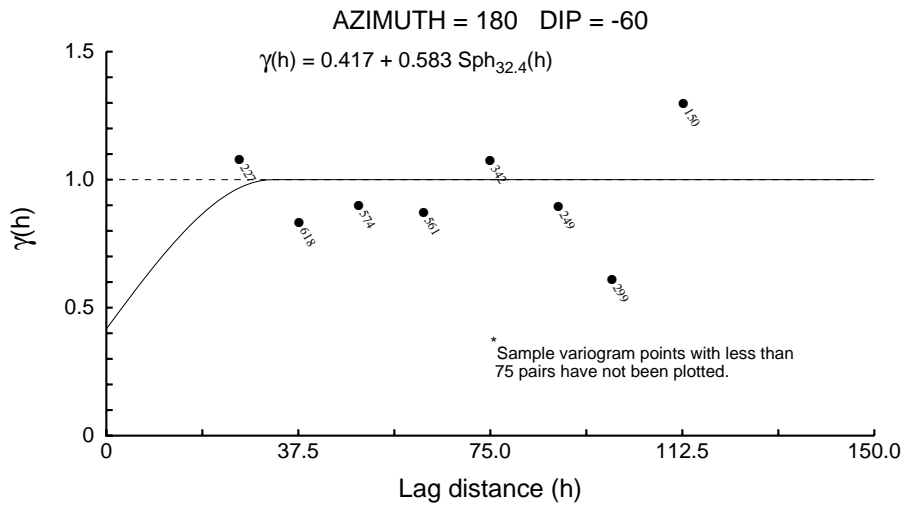
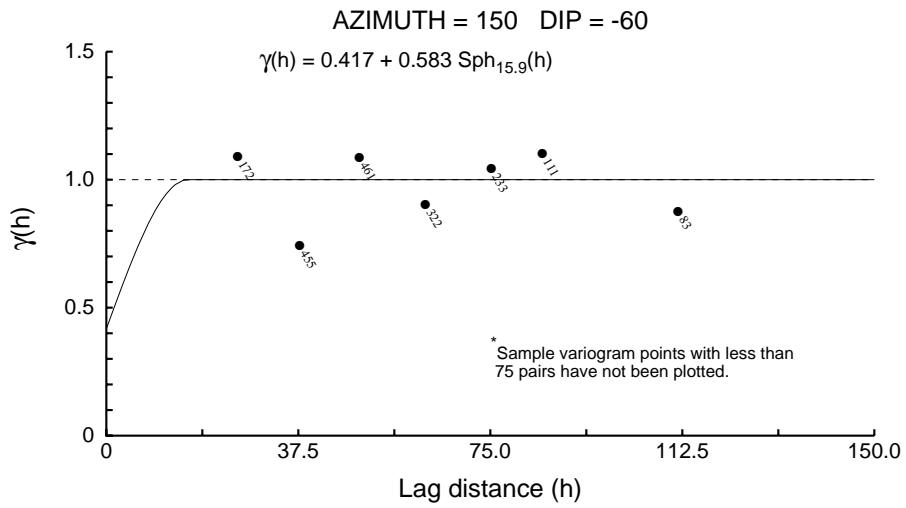
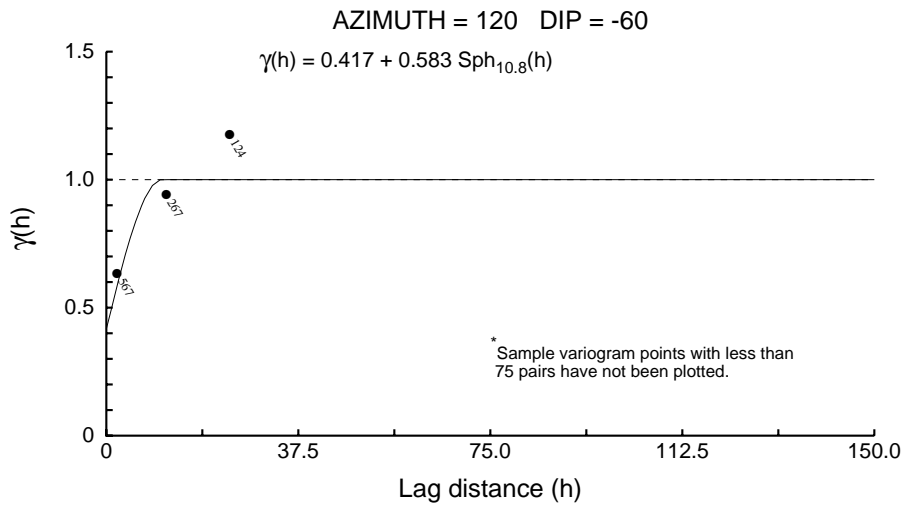

Ayelen Vein - AUCAP Correlograms

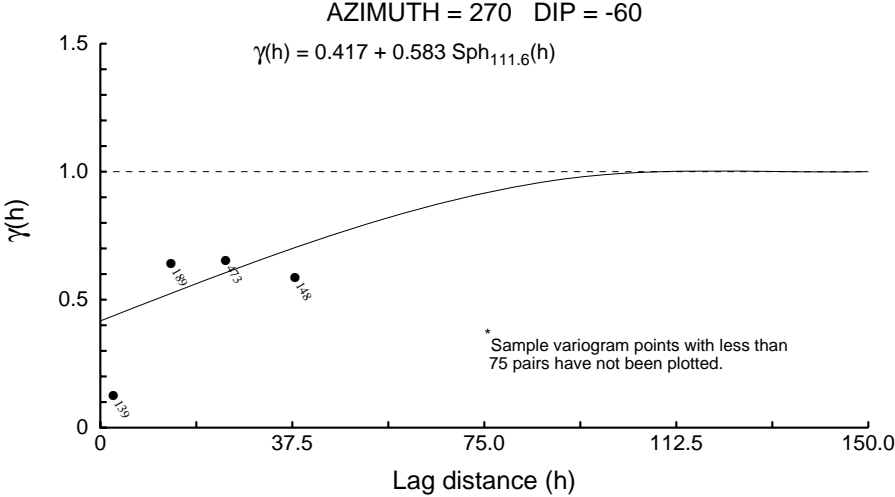
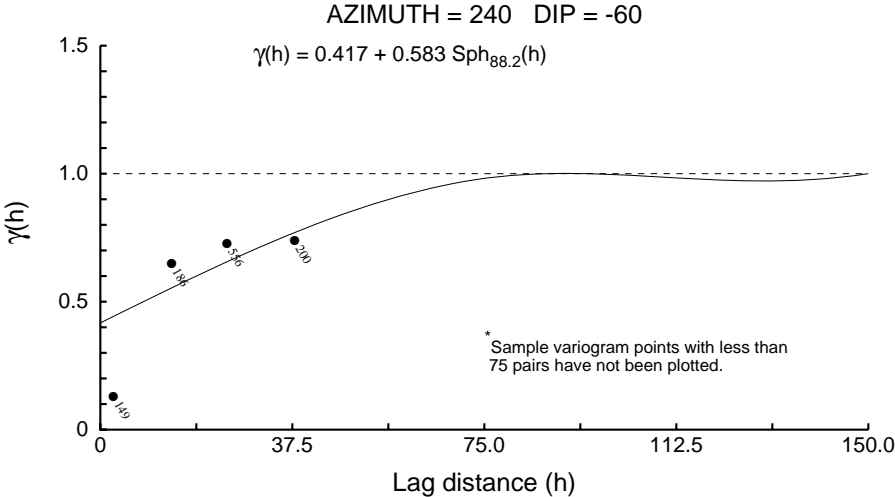
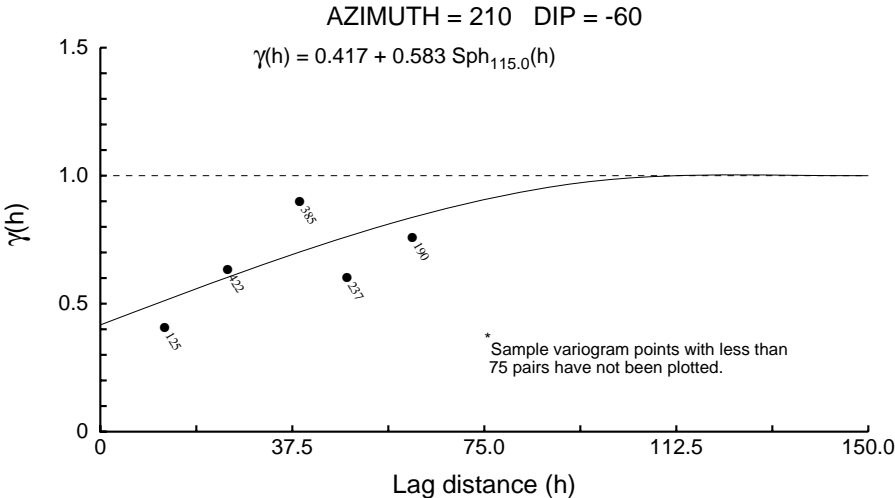

Ayelen Vein - AUCAP Correlograms

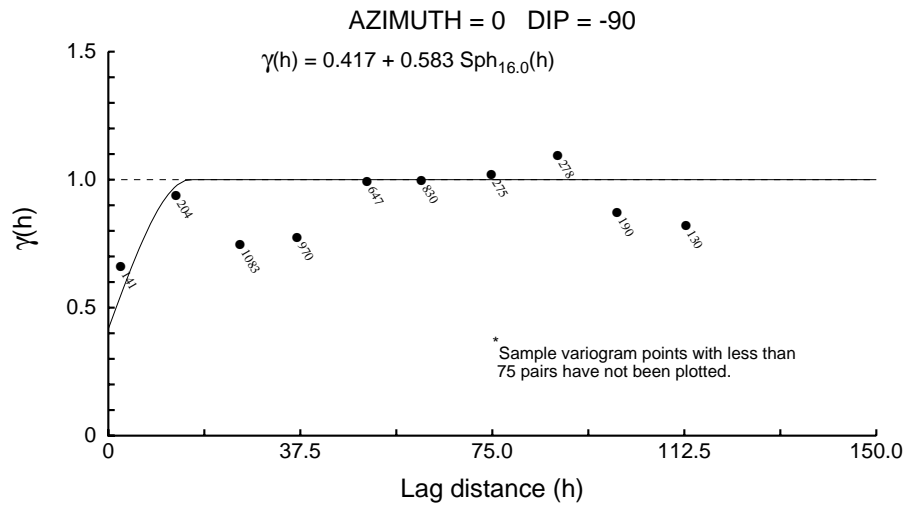
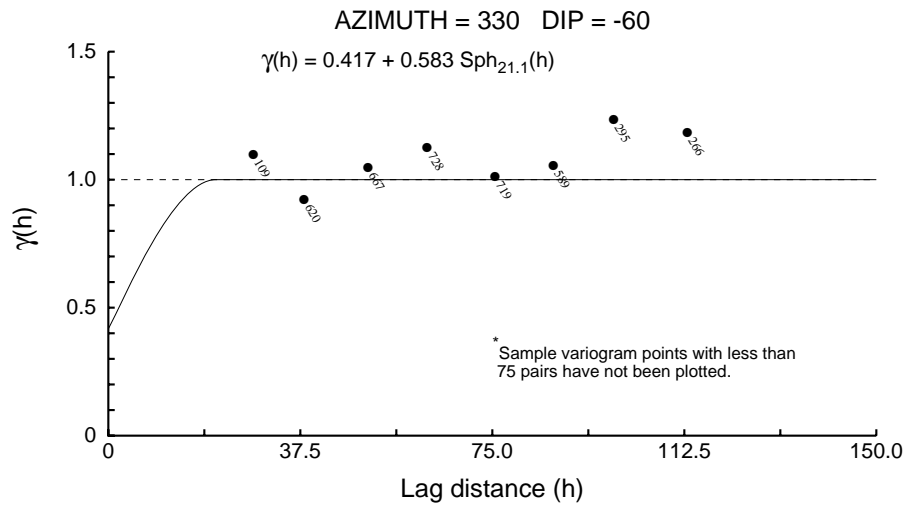
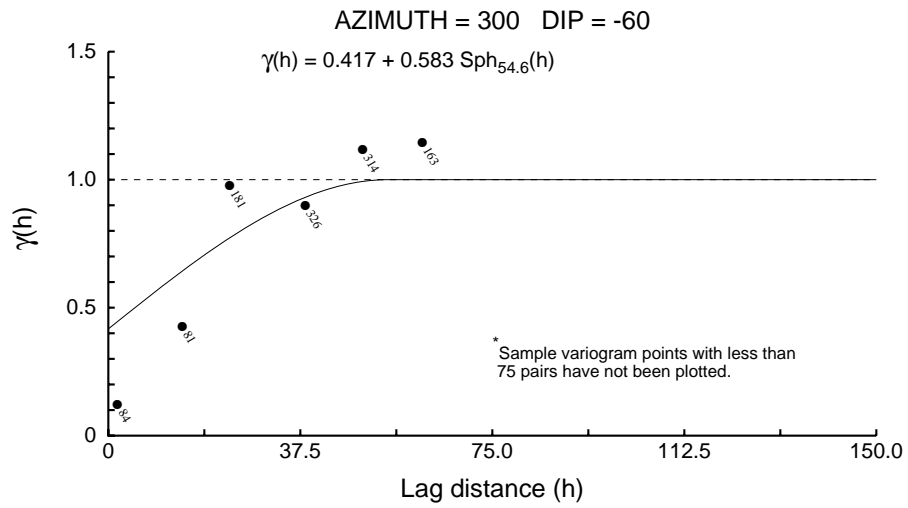

Ayelen Vein - AUCAP Correlograms

Medsystem and Vulcan Rotation Conventions

Nugget ==> 0.417

C1 ==> 0.583

First Structure -- Spherical

LH Rotation about the Z axis ==> 64

RH Rotation about the X' axis ==> 64

LH Rotation about the Y' axis ==> -87

Range along the Z' axis ==> 50.2

Azimuth ==> 157 Dip ==> 1

Range along the Y' axis ==> 149.3

Azimuth ==> 64 Dip ==> 64

Range along the X' axis ==> 6.6

Azimuth ==> 67 Dip ==> -26

Modeling Criteria

Minimum number pairs req'd ==> 75

Sample variogram points weighted by # pairs

Ayelen Vein - AUCAP Correlograms

Structure Number 1

Rose Diagram of Ranges Dipping 0 Degrees

Scale:

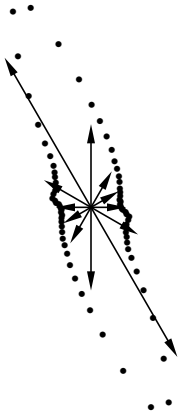

Ayelen Vein - AUCAP Correlograms

Structure Number 1

Rose Diagram of Ranges Dipping 30 Degrees

Scale:

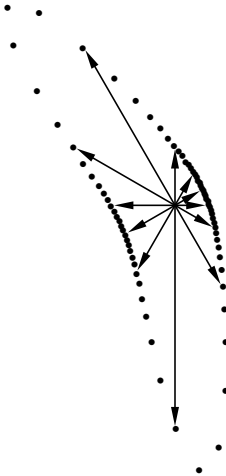

Ayelen Vein - AUCAP Correlograms

Structure Number 1

Rose Diagram of Ranges Dipping 60 Degrees

Scale:

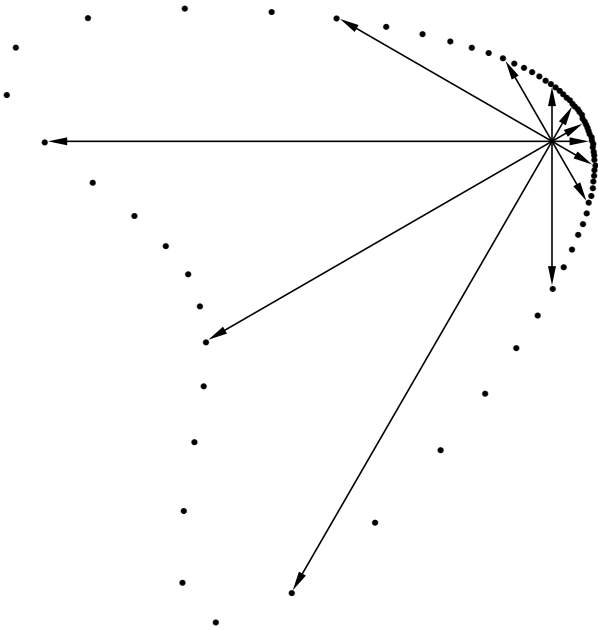
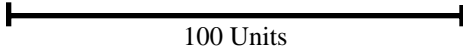

Horizontal Slices Through the Ellipsoids

Reference Cube

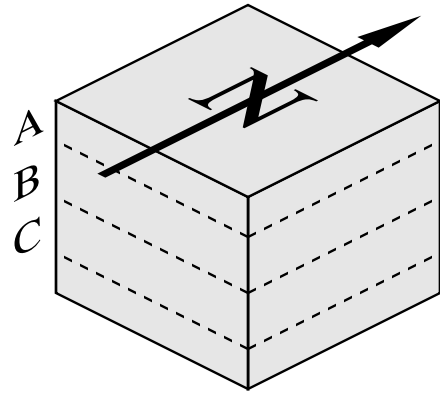

X-Y Planes Looking Down

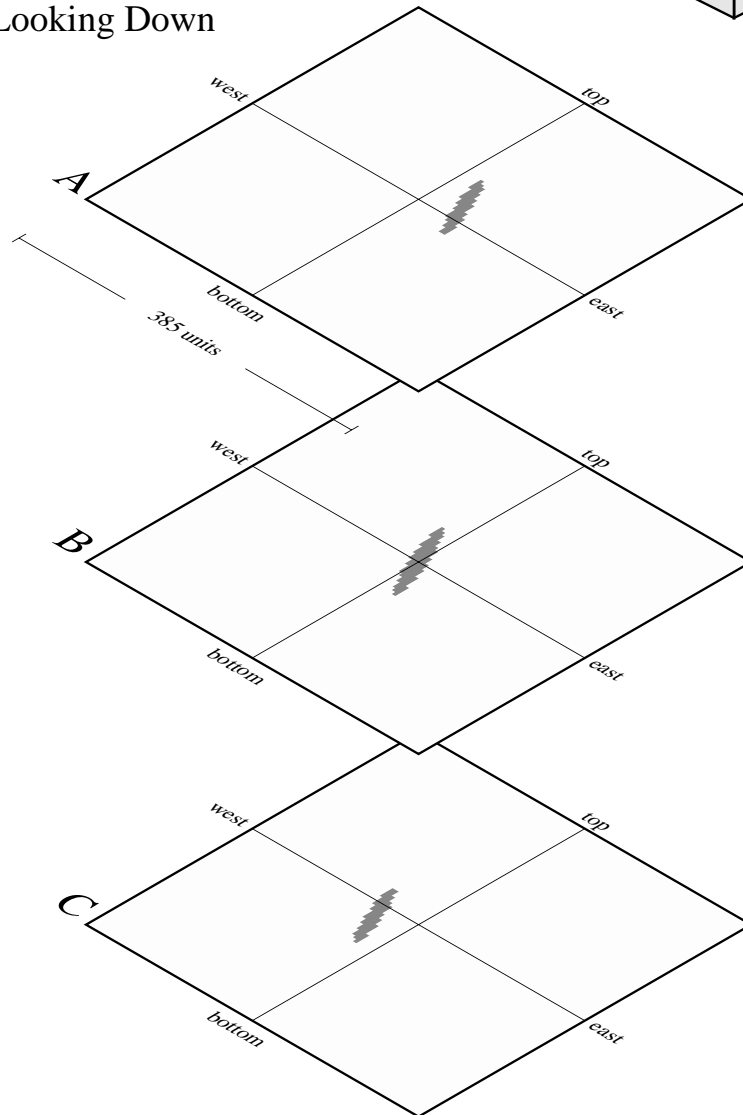

Note -- the orientation, dip and lengths of the ellipsoid axes in these figures may be "apparent" rather than "true".

Cross Section Views Through the Ellipsoids

Reference Cube

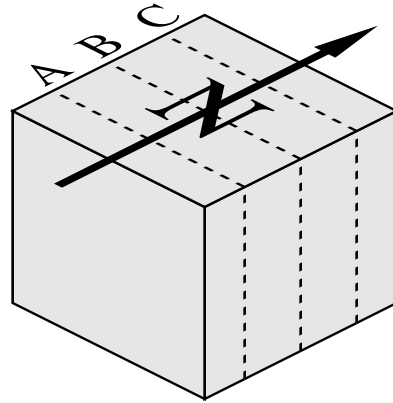

X-Z Planes Looking North

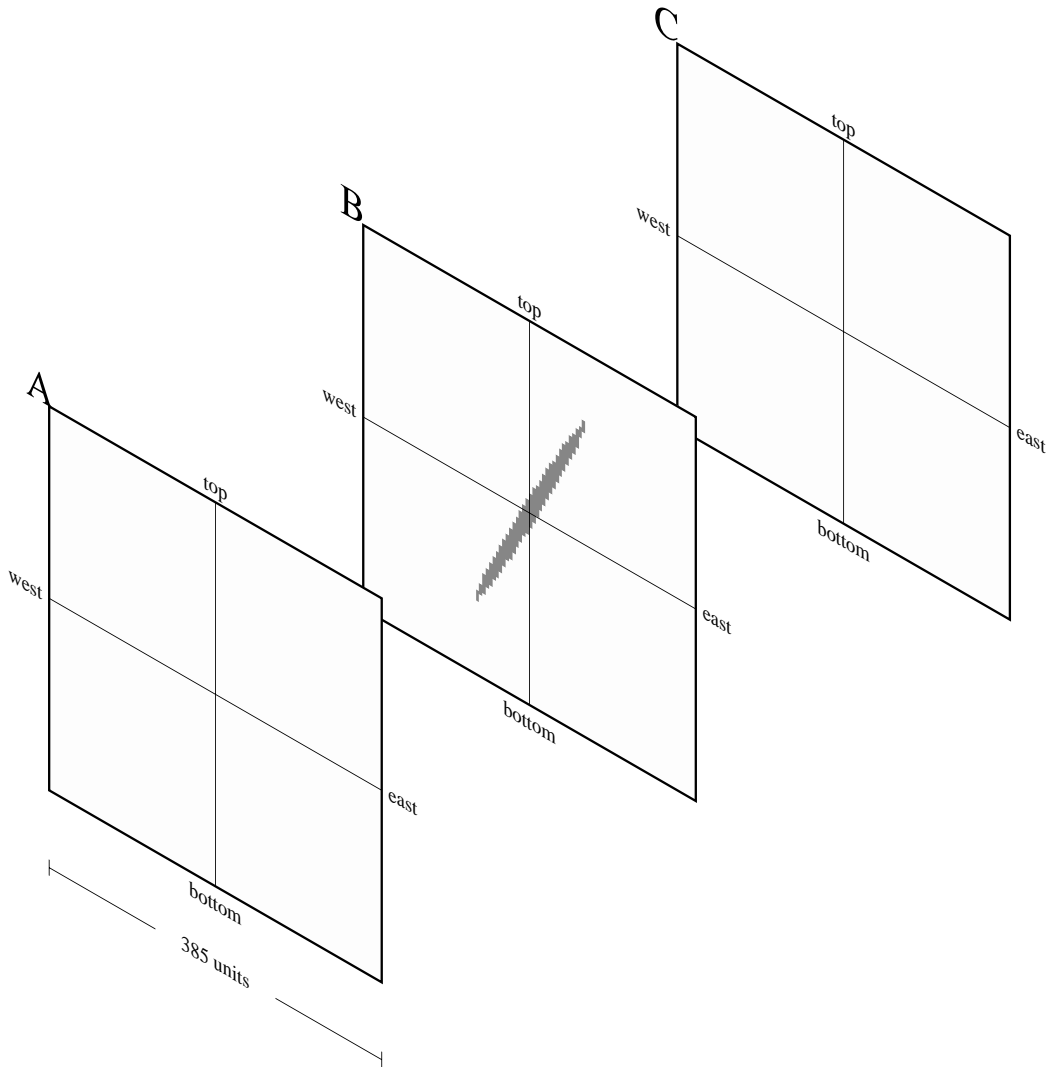

Note -- the orientation, dip and lengths of the ellipsoid axes in these figures may be "apparent" rather than "true".

Long Section Views Through the Ellipsoids

Reference Cube

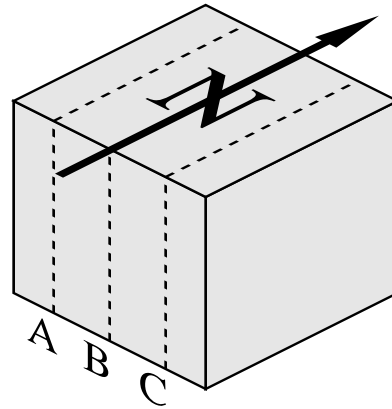

Y-Z Planes Looking West

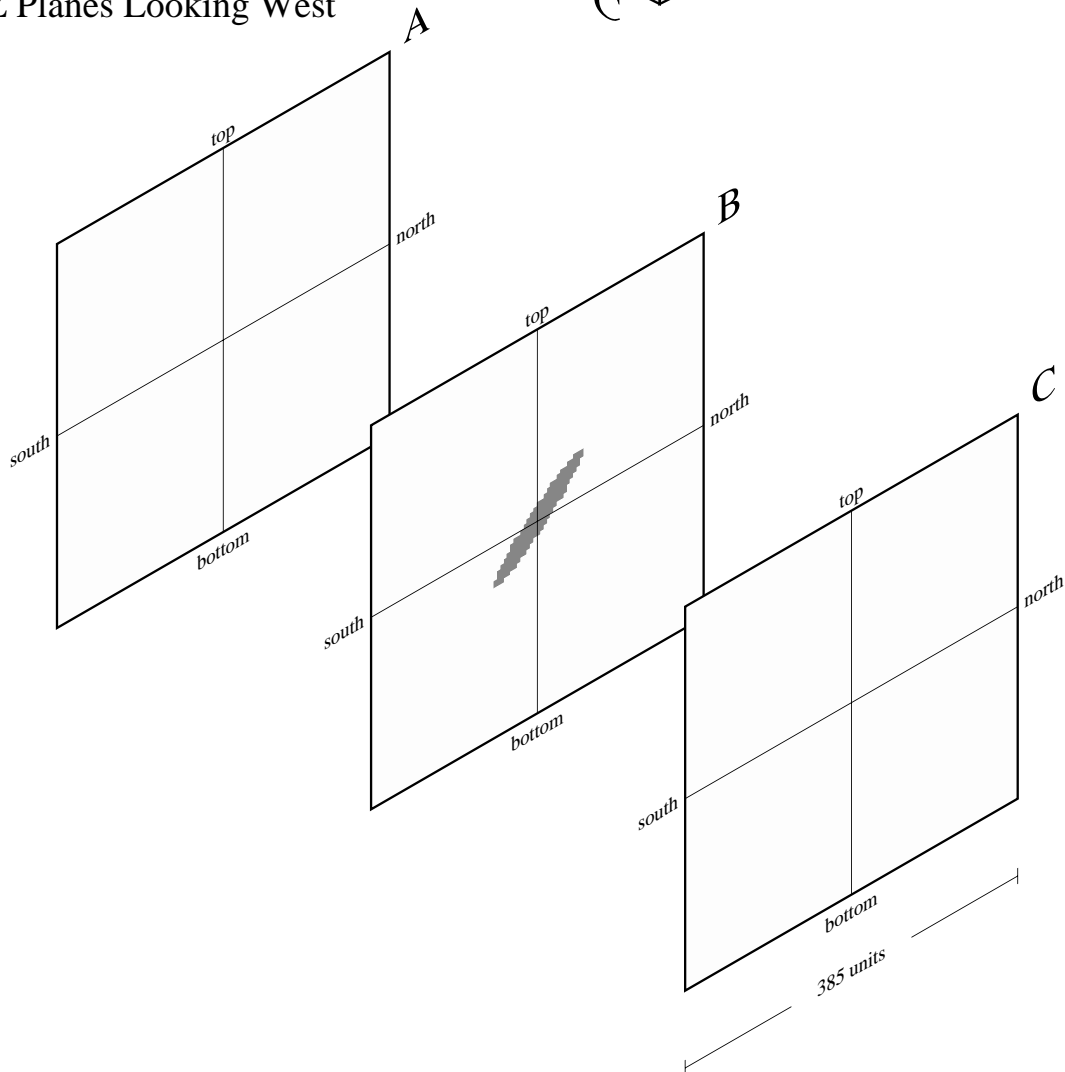

Note -- the orientation, dip and lengths of the ellipsoid axes in these figures may be "apparent" rather than "true".

**Updated Mineral Resource Estimate San Luis Project,
Ancash Department, Perú
January 9, 2009**

APPENDIX 2: Silver Correlograms

Ayelen Vein - AGCAP Correlograms

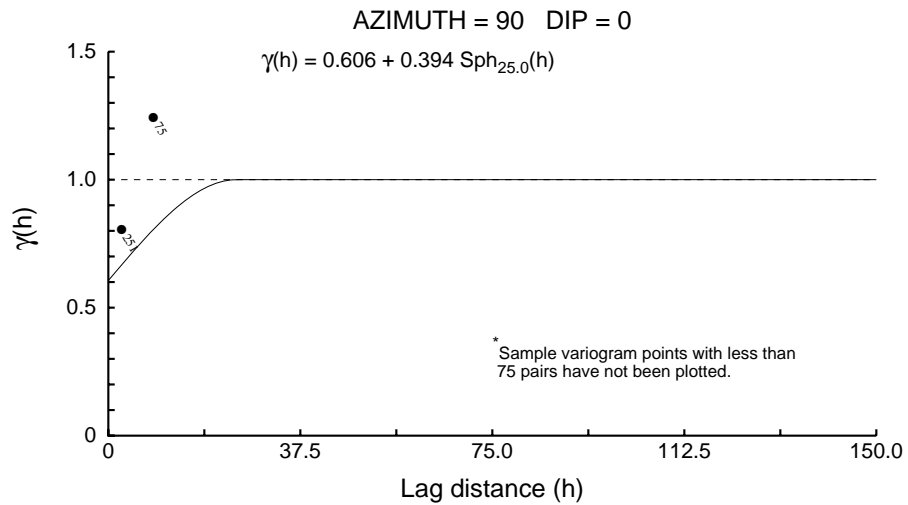
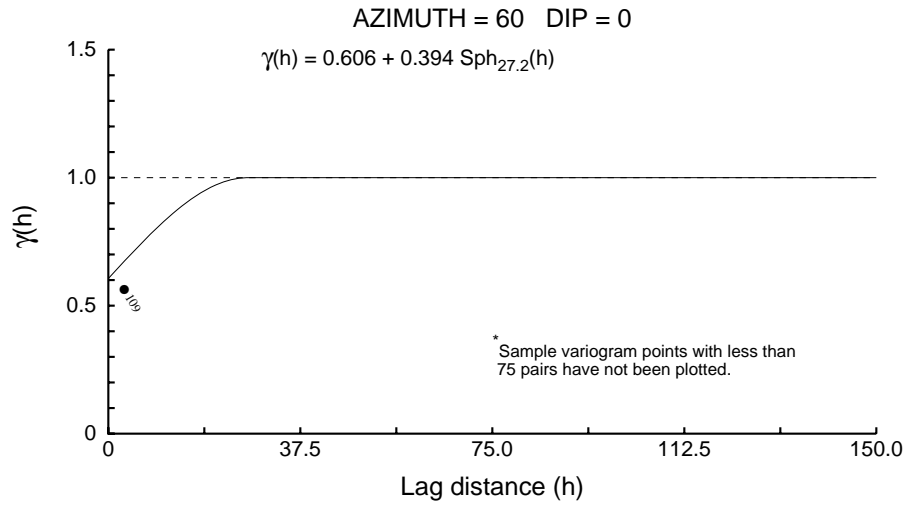
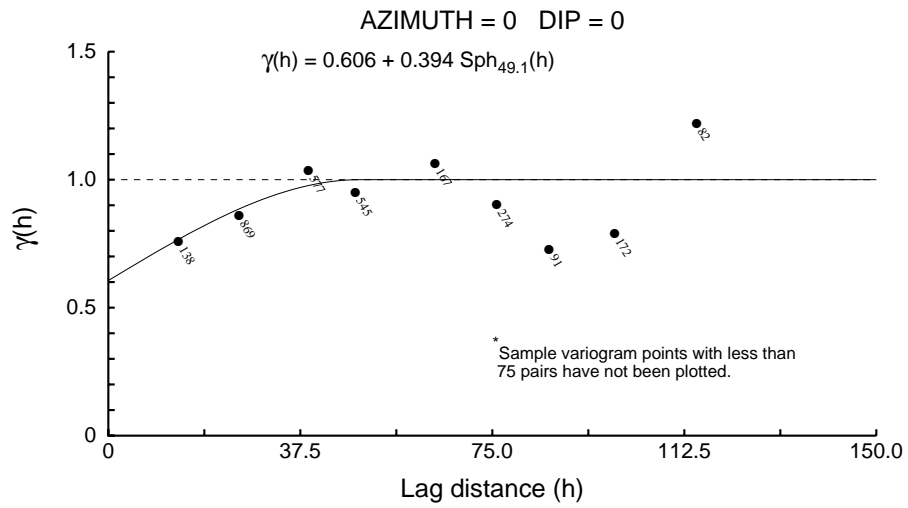

Ayelen Vein - AGCAP Correlograms

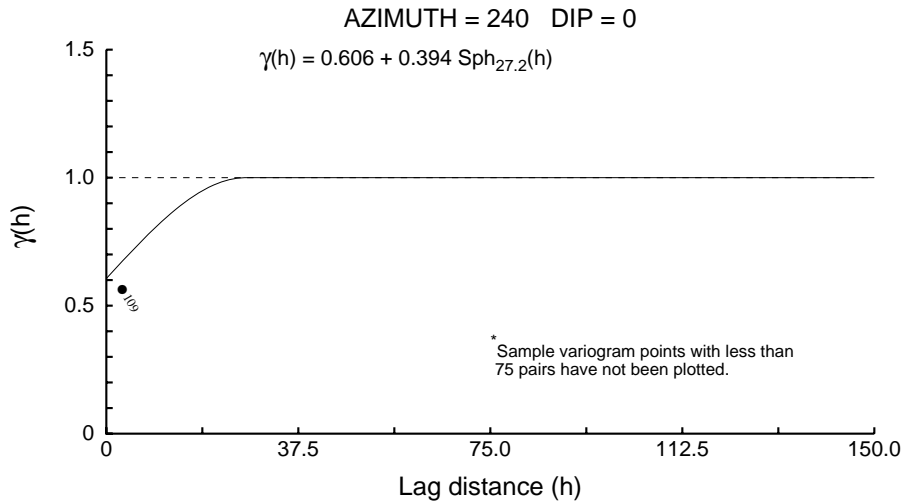
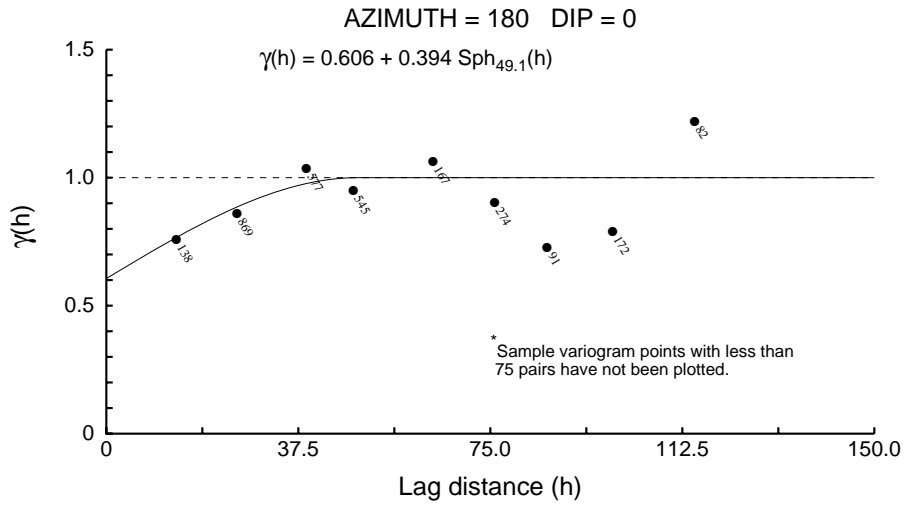
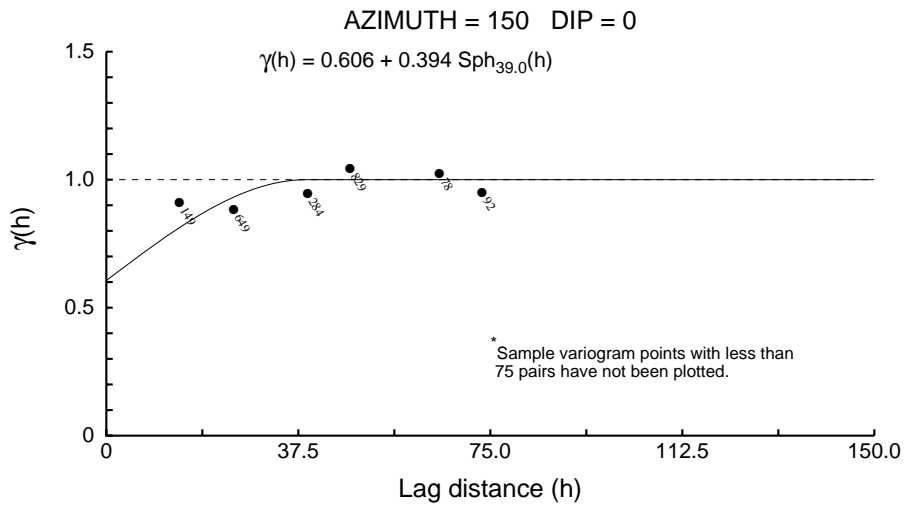

Ayelen Vein - AGCAP Correlograms

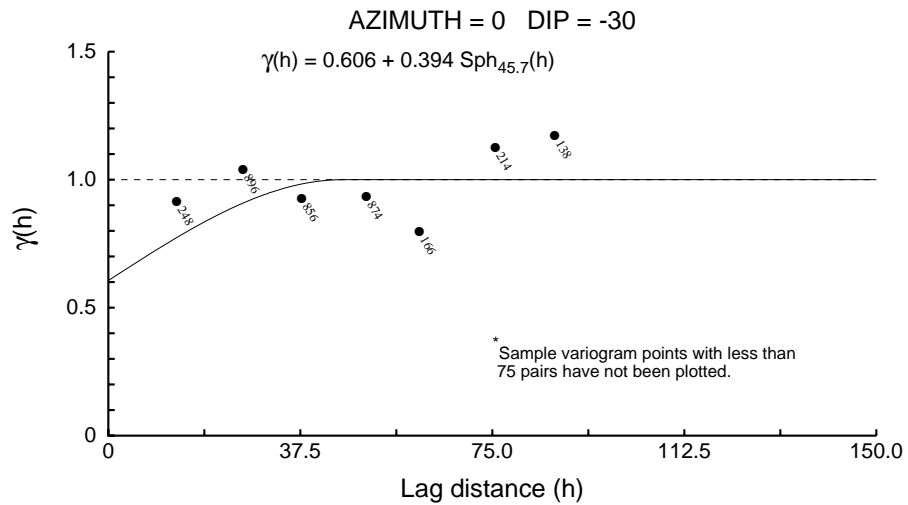
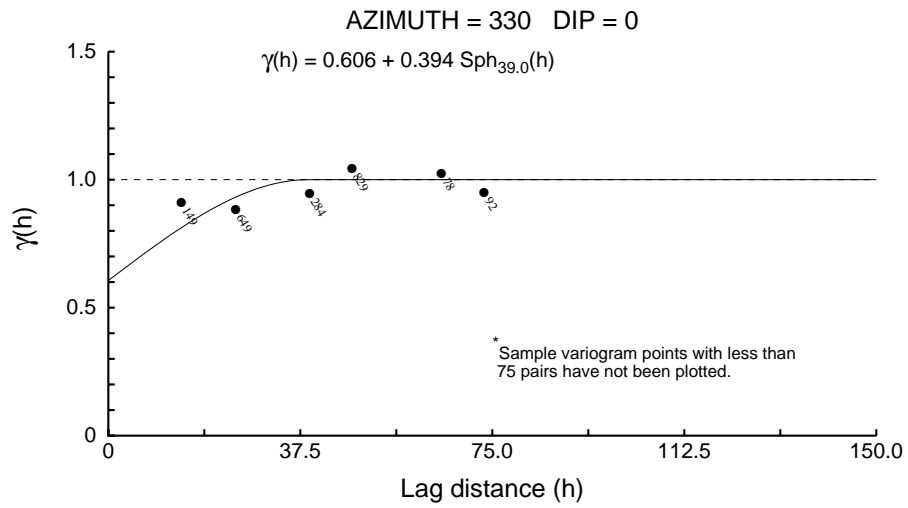
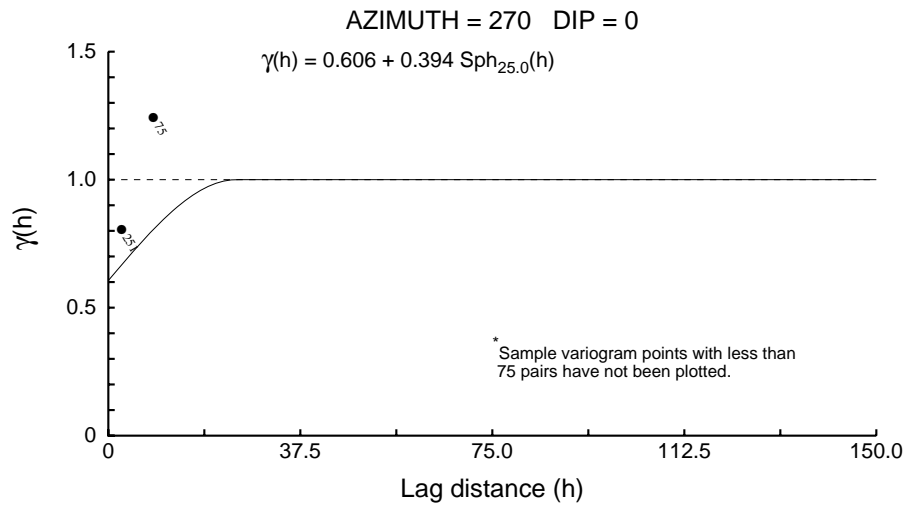

Ayelen Vein - AGCAP Correlograms

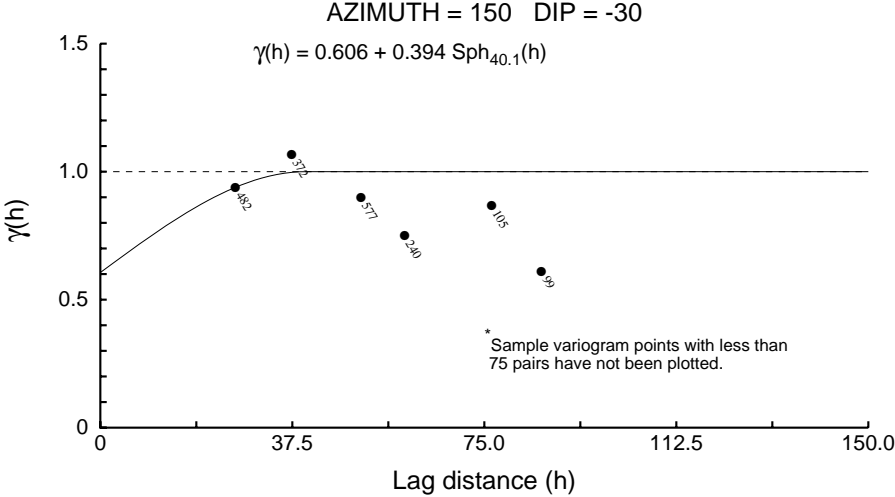
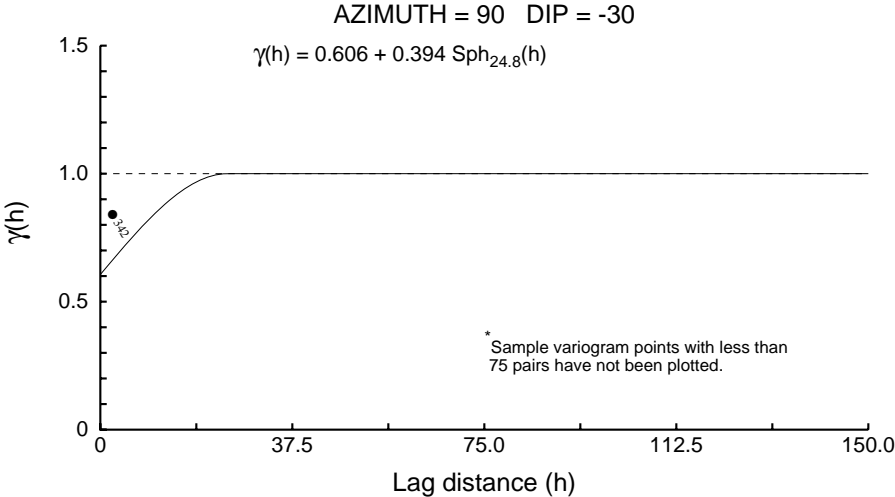
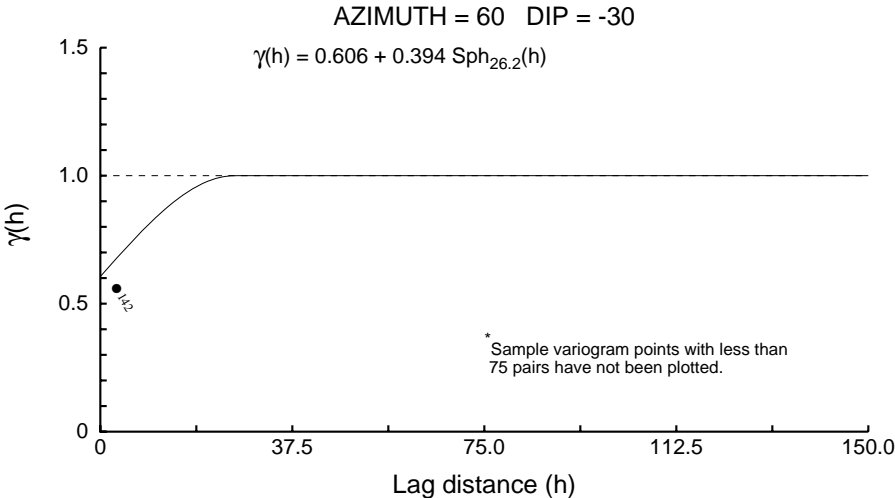

Ayelen Vein - AGCAP Correlograms

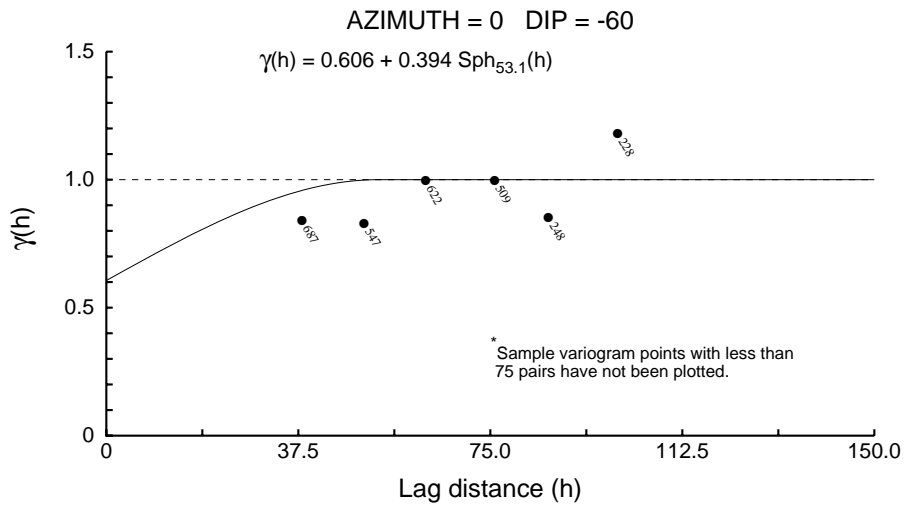
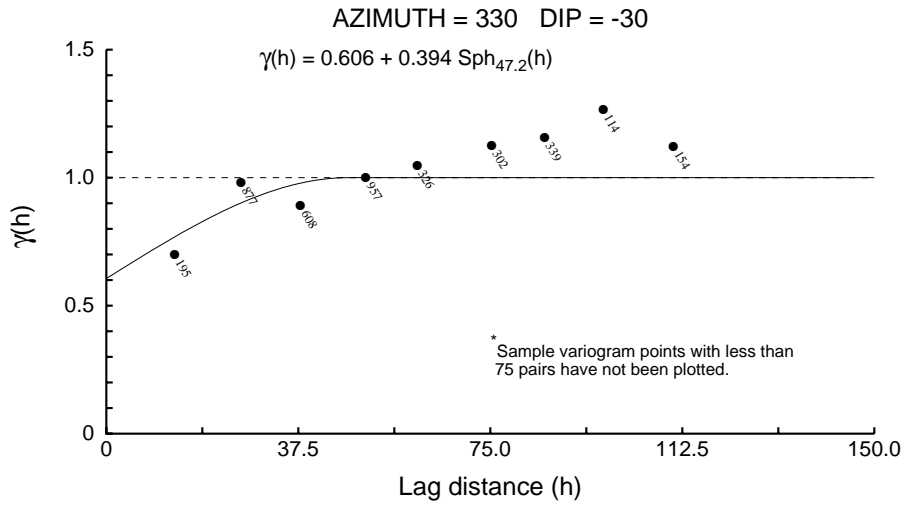
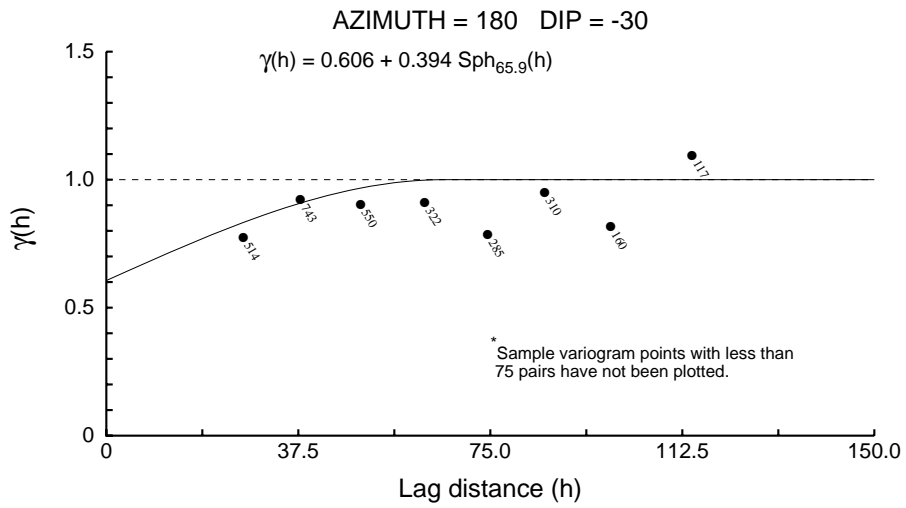

Ayelen Vein - AGCAP Correlograms

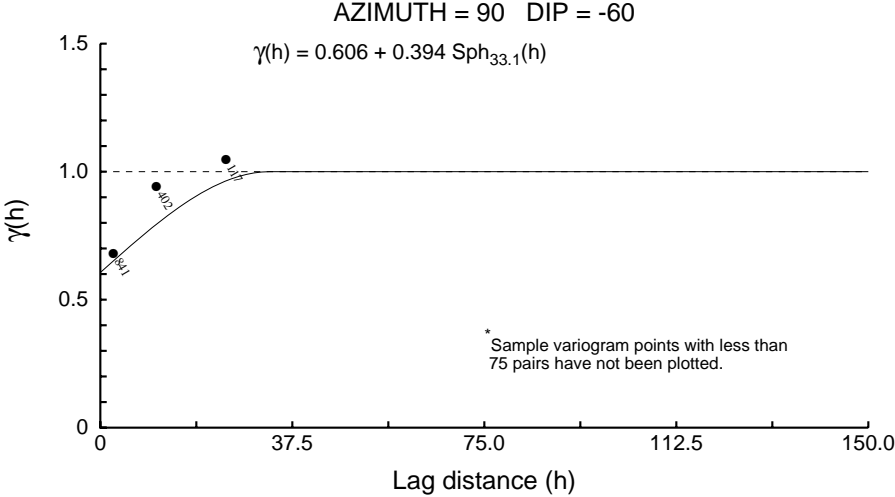
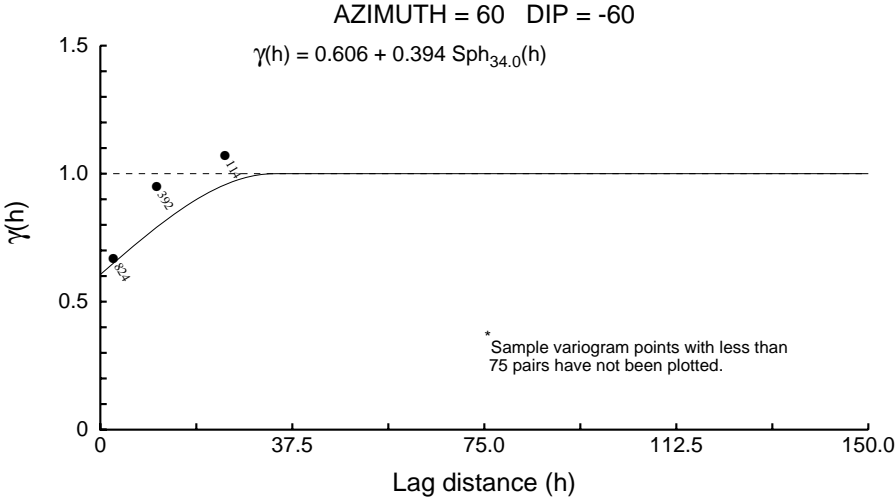
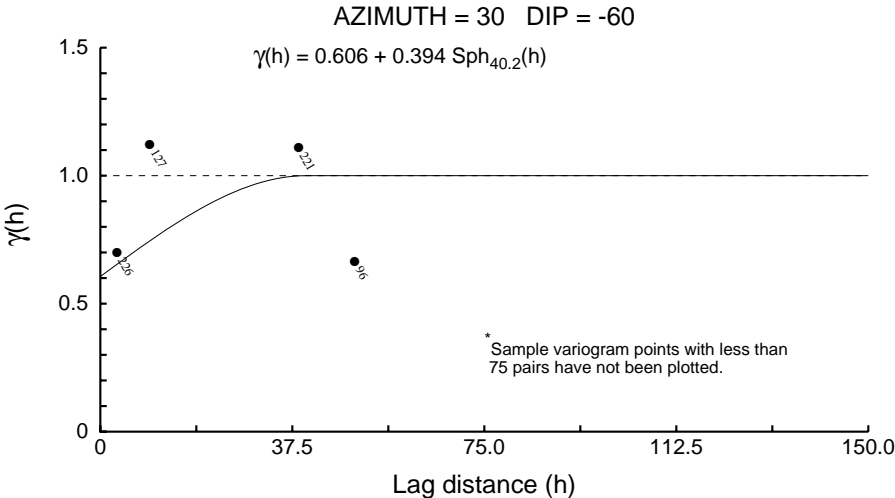

Ayelen Vein - AGCAP Correlograms

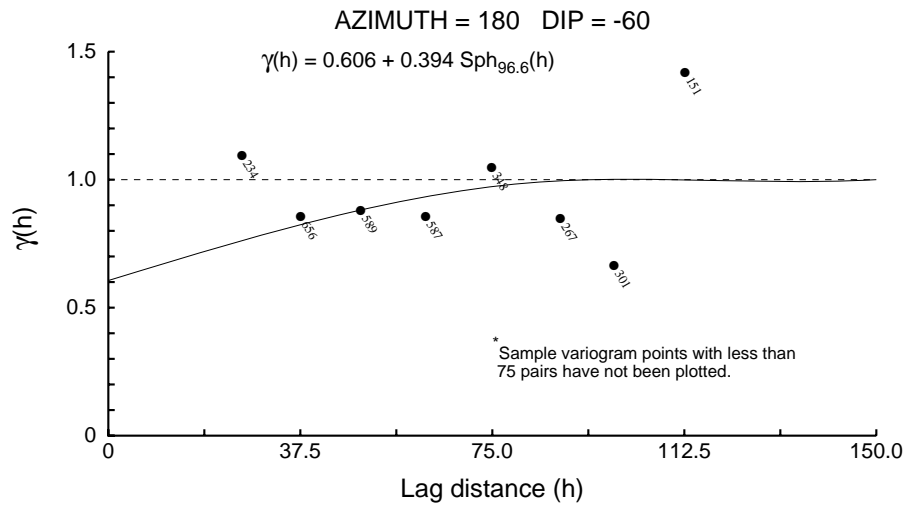
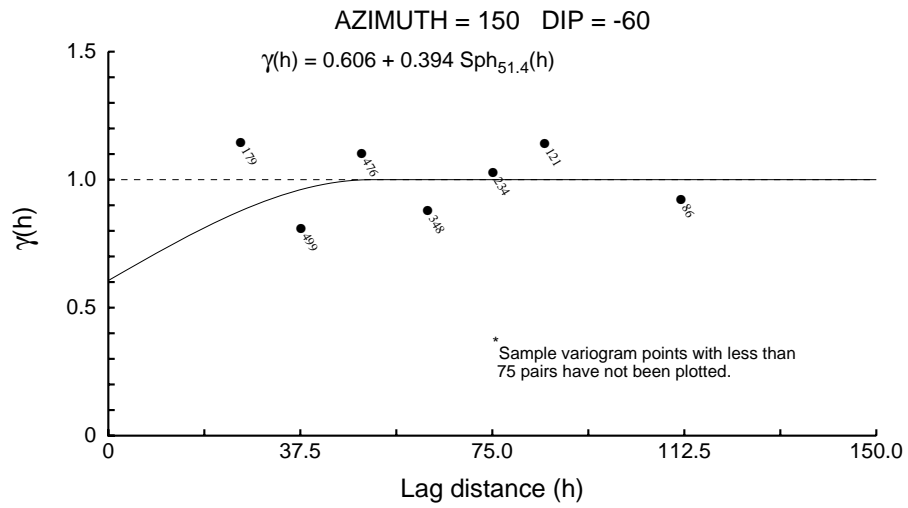
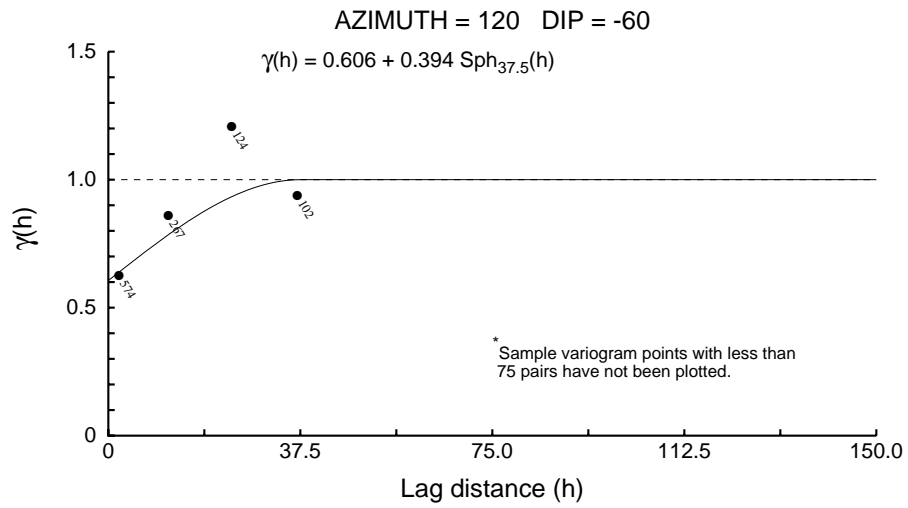

Ayelen Vein - AGCAP Correlograms

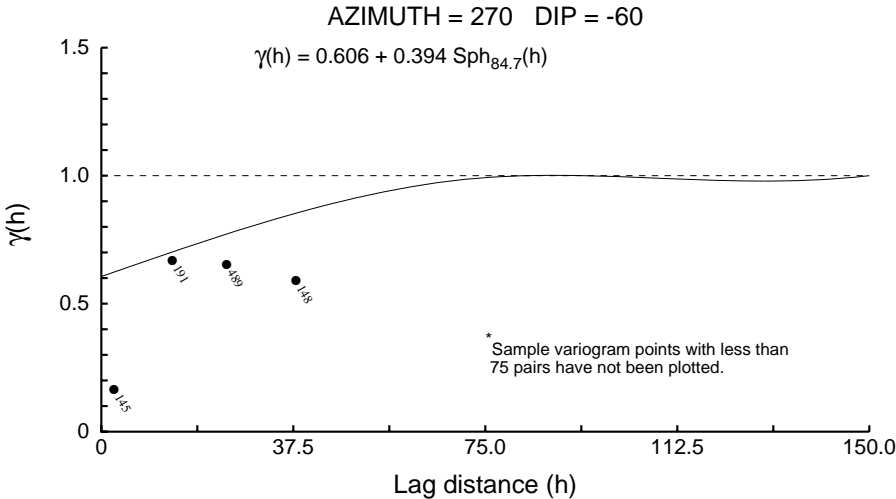
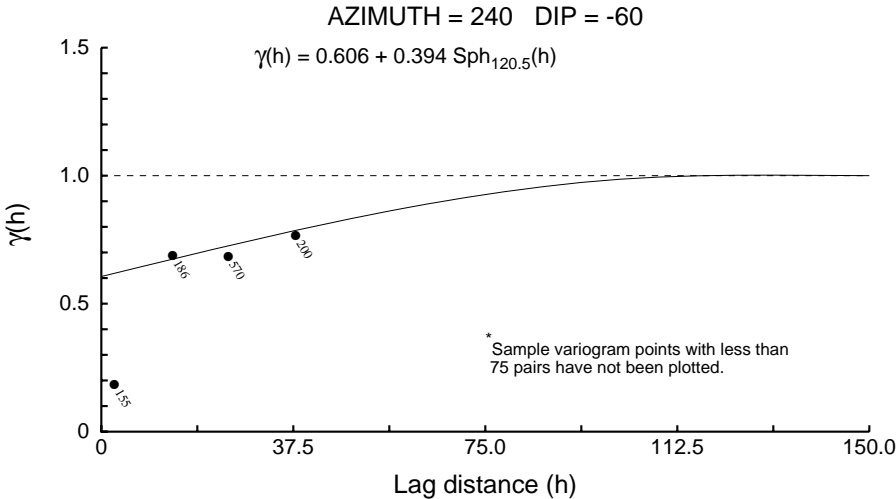
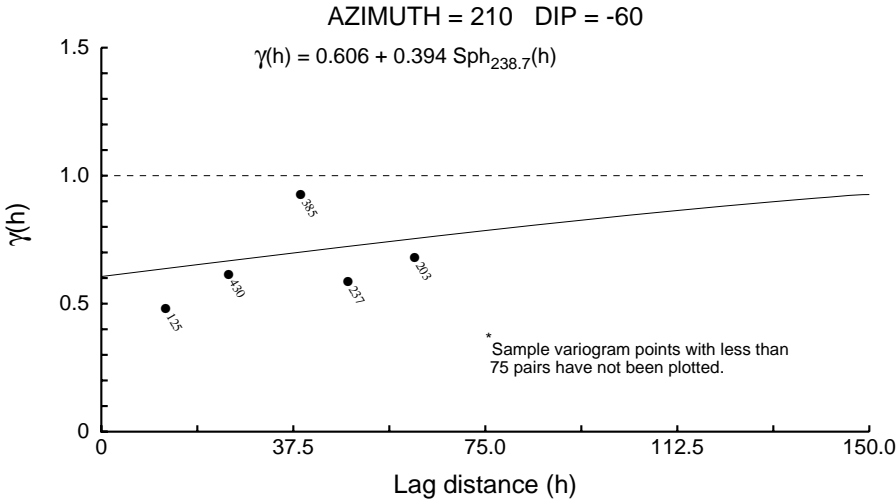

Ayelen Vein - AGCAP Correlograms

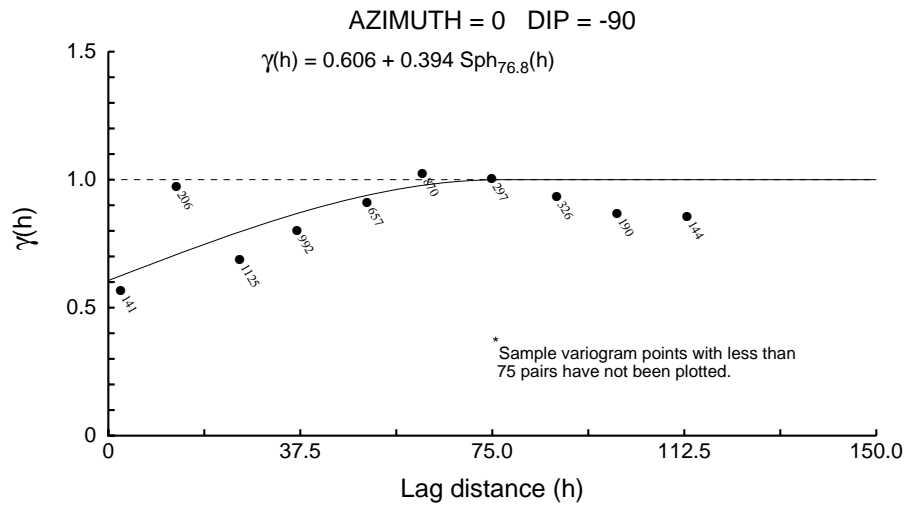
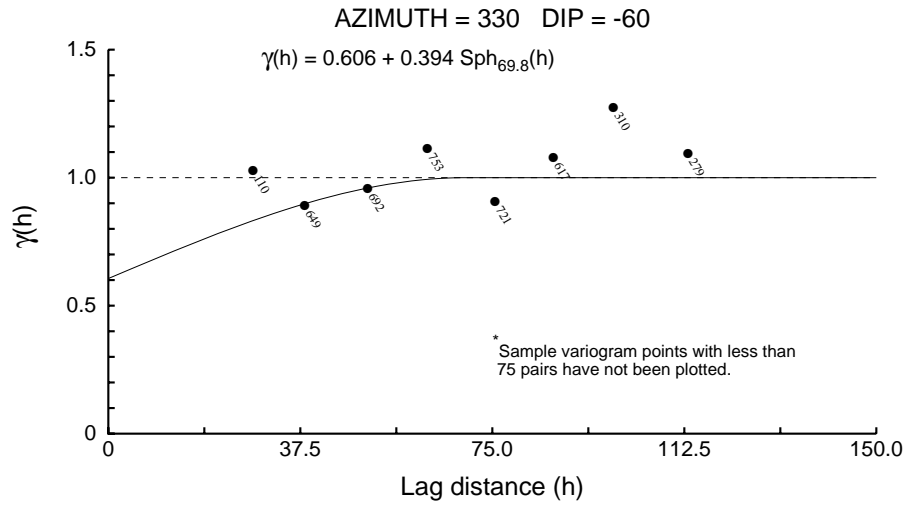
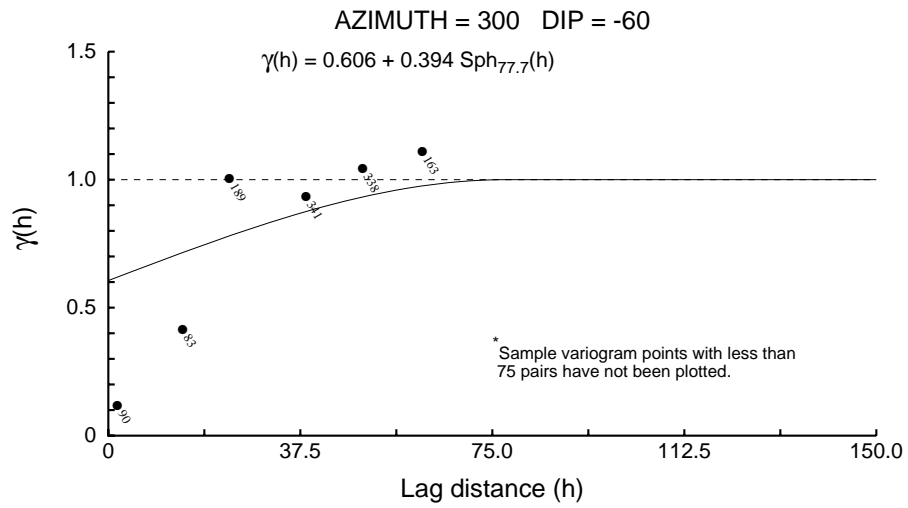

Ayelen Vein - AGCAP Correlograms

Medsystem and Vulcan Rotation Conventions

Nugget ==> 0.606

C1 ==> 0.394

First Structure -- Spherical

LH Rotation about the Z axis ==> 41

RH Rotation about the X' axis ==> 68

LH Rotation about the Y' axis ==> -48

Range along the Z' axis ==> 44.7 Azimuth ==> 171 Dip ==> 15

Range along the Y' axis ==> 401.4 Azimuth ==> 41 Dip ==> 68

Range along the X' axis ==> 22.7 Azimuth ==> 85 Dip ==> -16

Modeling Criteria

Minimum number pairs req'd ==> 75

Sample variogram points weighted by # pairs

Ayelen Vein - AGCAP Correlograms

Structure Number 1

Rose Diagram of Ranges Dipping 0 Degrees

Scale:

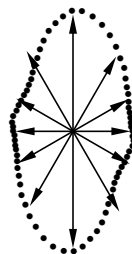

Ayelen Vein - AGCAP Correlograms

Structure Number 1

Rose Diagram of Ranges Dipping 30 Degrees

Scale:

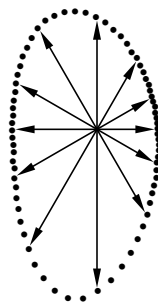

Ayelen Vein - AGCAP Correlograms

Structure Number 1

Rose Diagram of Ranges Dipping 60 Degrees

Scale:

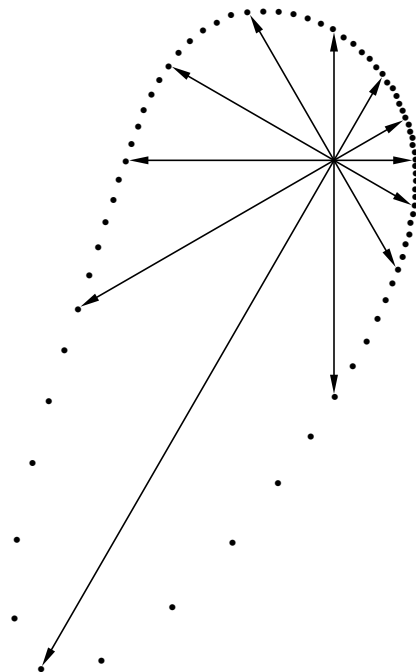

Horizontal Slices Through the Ellipsoids

Reference Cube

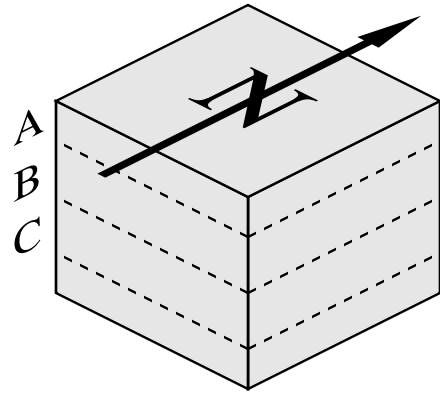

X-Y Planes Looking Down

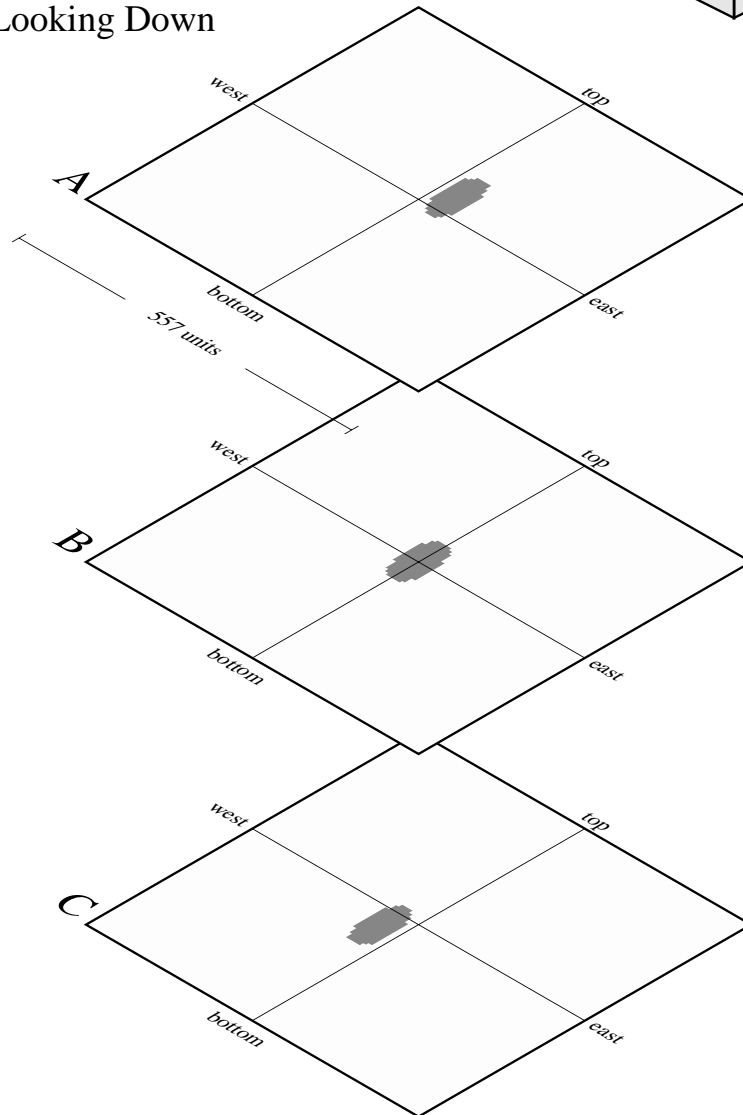

Note -- the orientation, dip and lengths of the ellipsoid axes in these figures may be "apparent" rather than "true".

Cross Section Views Through the Ellipsoids

Reference Cube

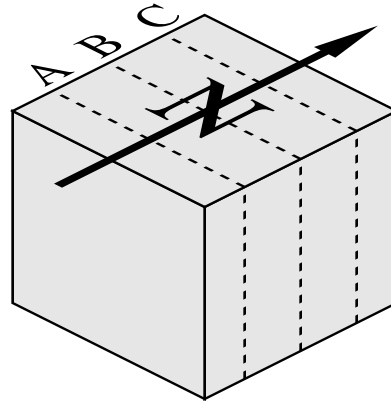

X-Z Planes Looking North

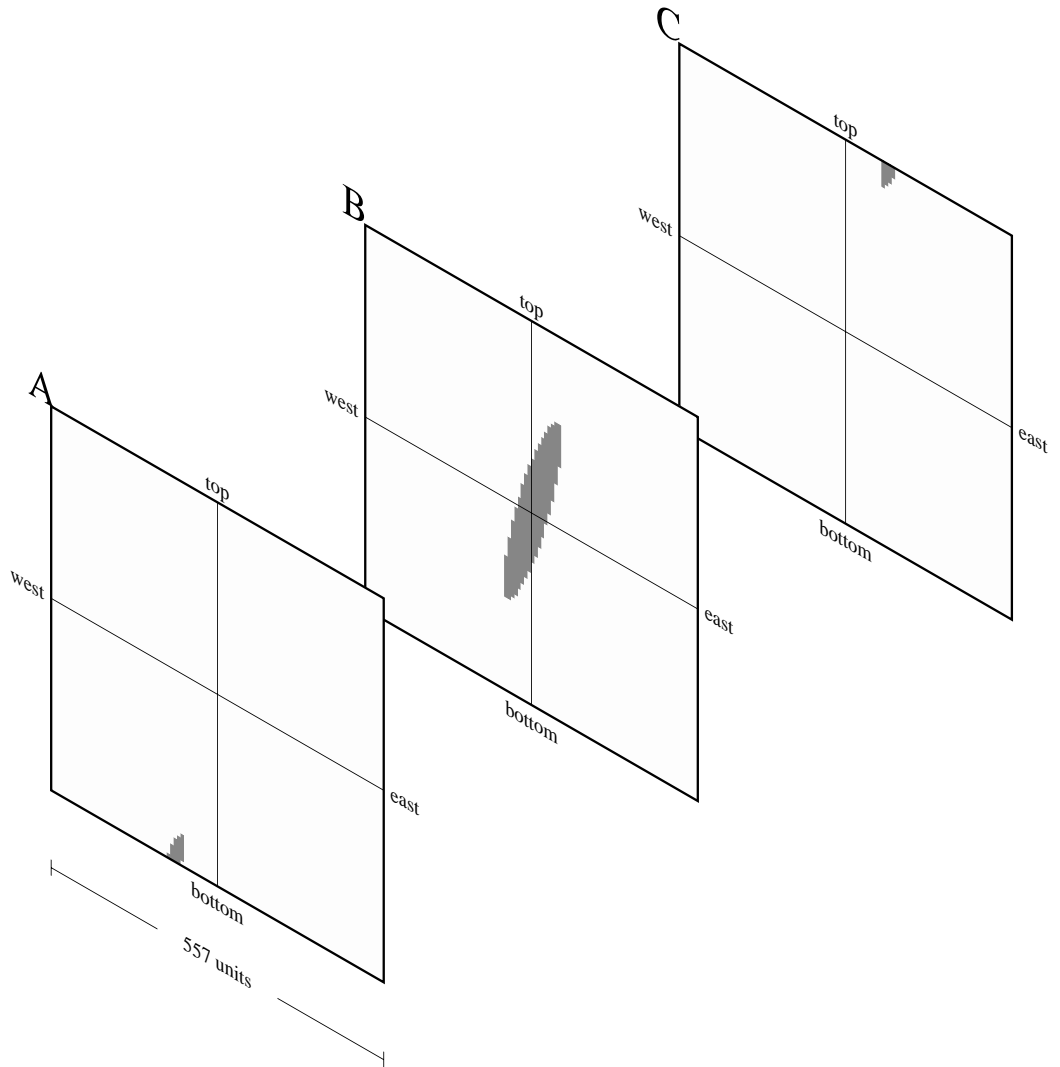

Note -- the orientation, dip and lengths of the ellipsoid axes in these figures may be "apparent" rather than "true".

Long Section Views Through the Ellipsoids

Reference Cube

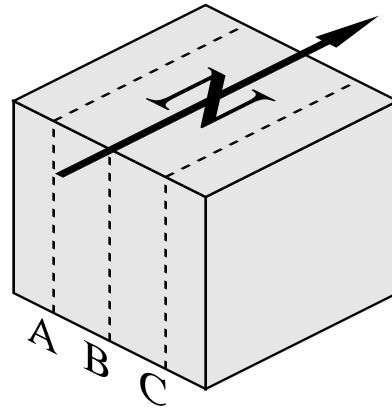

Y-Z Planes Looking West

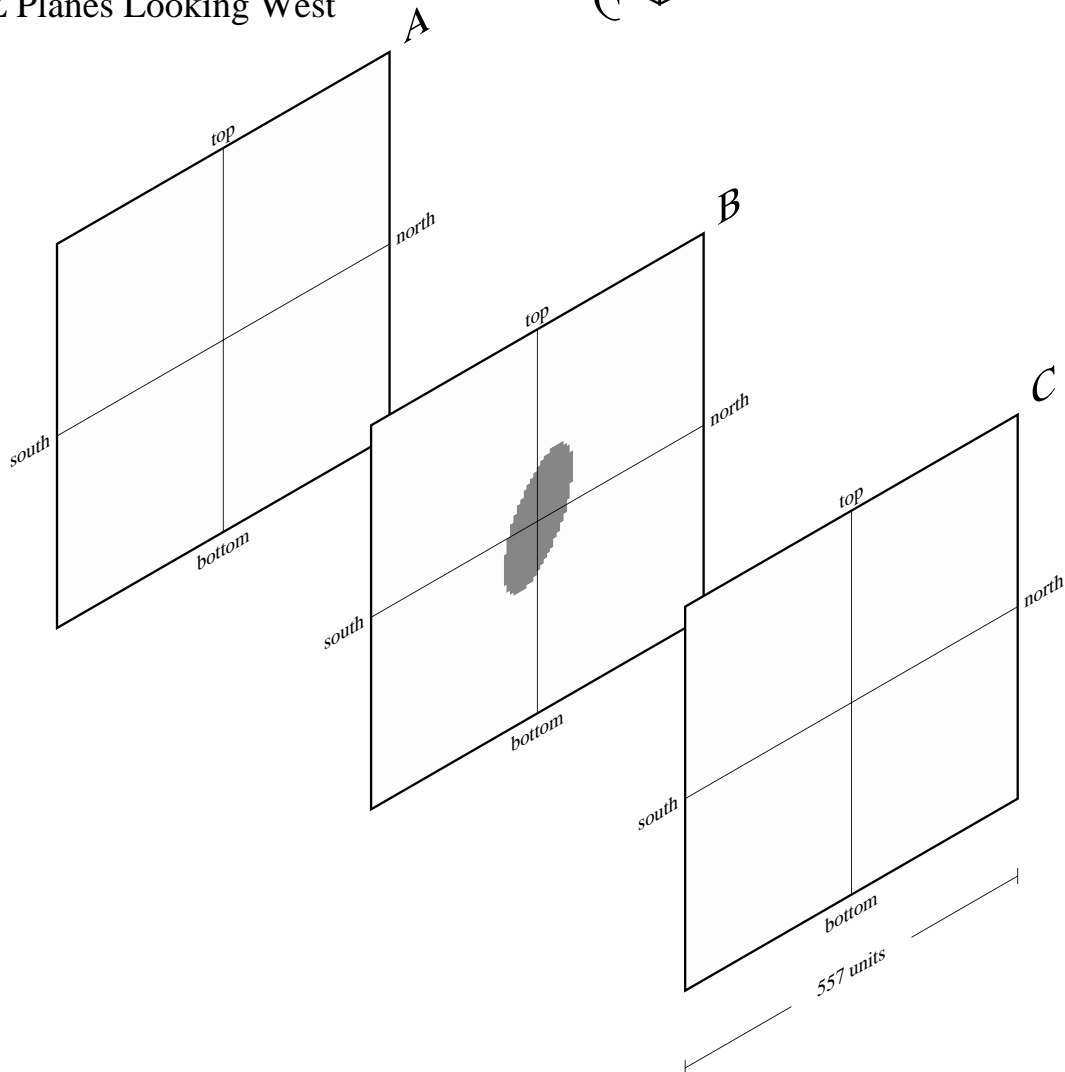

Note -- the orientation, dip and lengths of the ellipsoid axes in these figures may be "apparent" rather than "true".

**Updated Mineral Resource Estimate San Luis Project,
Ancash Department, Perú
January 9, 2009**

APPENDIX 3: Gold Cross Sections

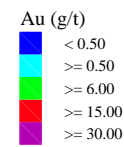
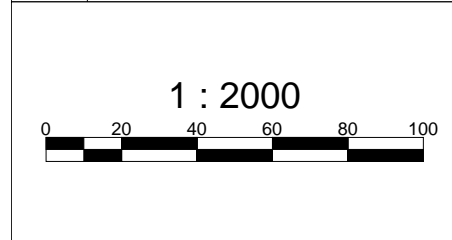
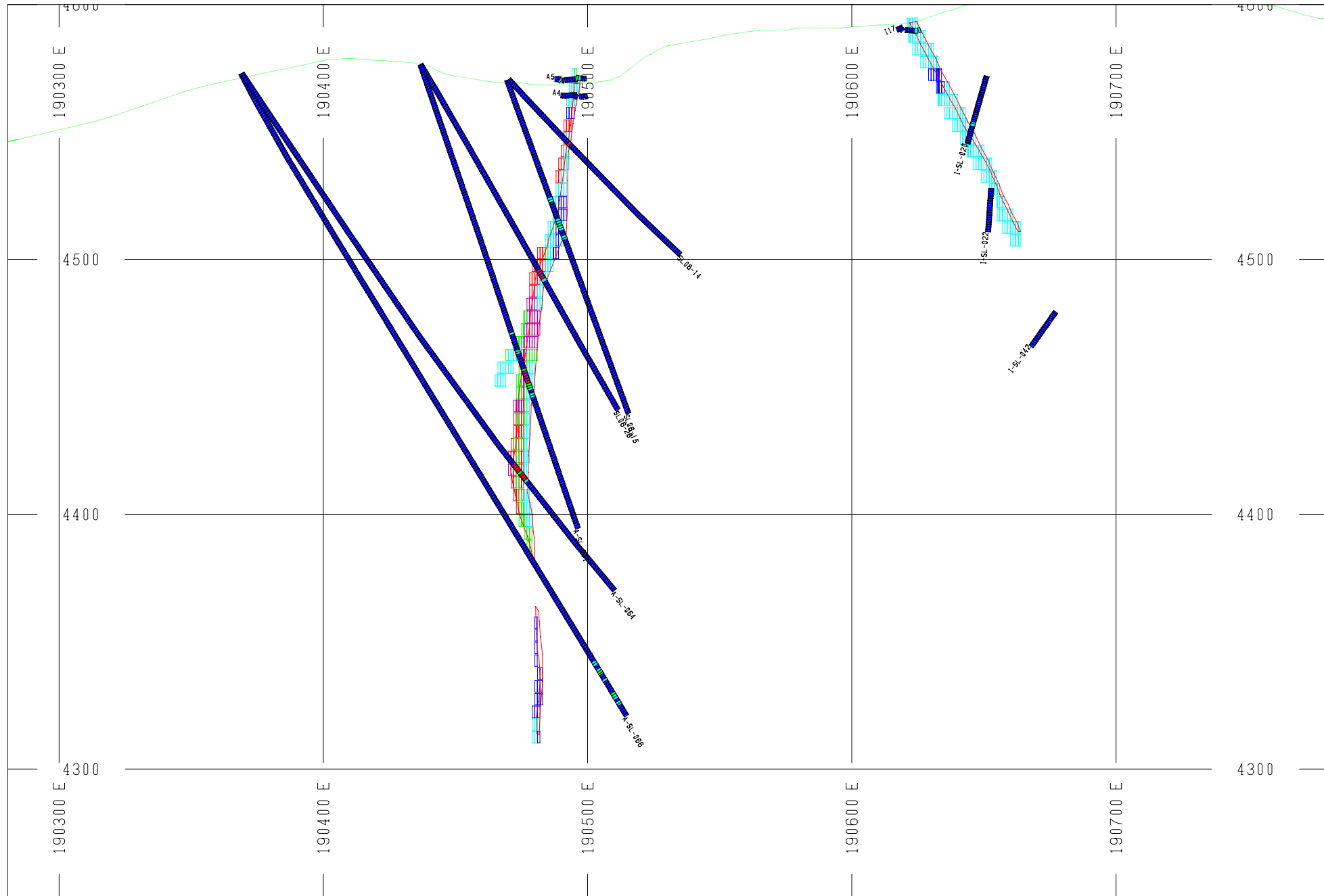

DATE:	Dec 09, 2008
SCALE:	1: 2000
FILE:	Section 1750.pdf

San Luis Project, Peru

Gold Cross Section

Section 1750 - View Looking N15W

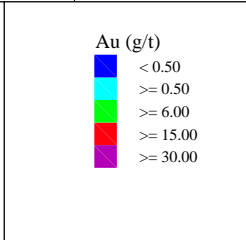
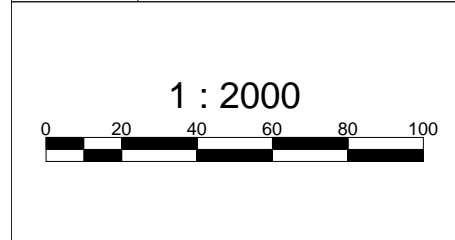
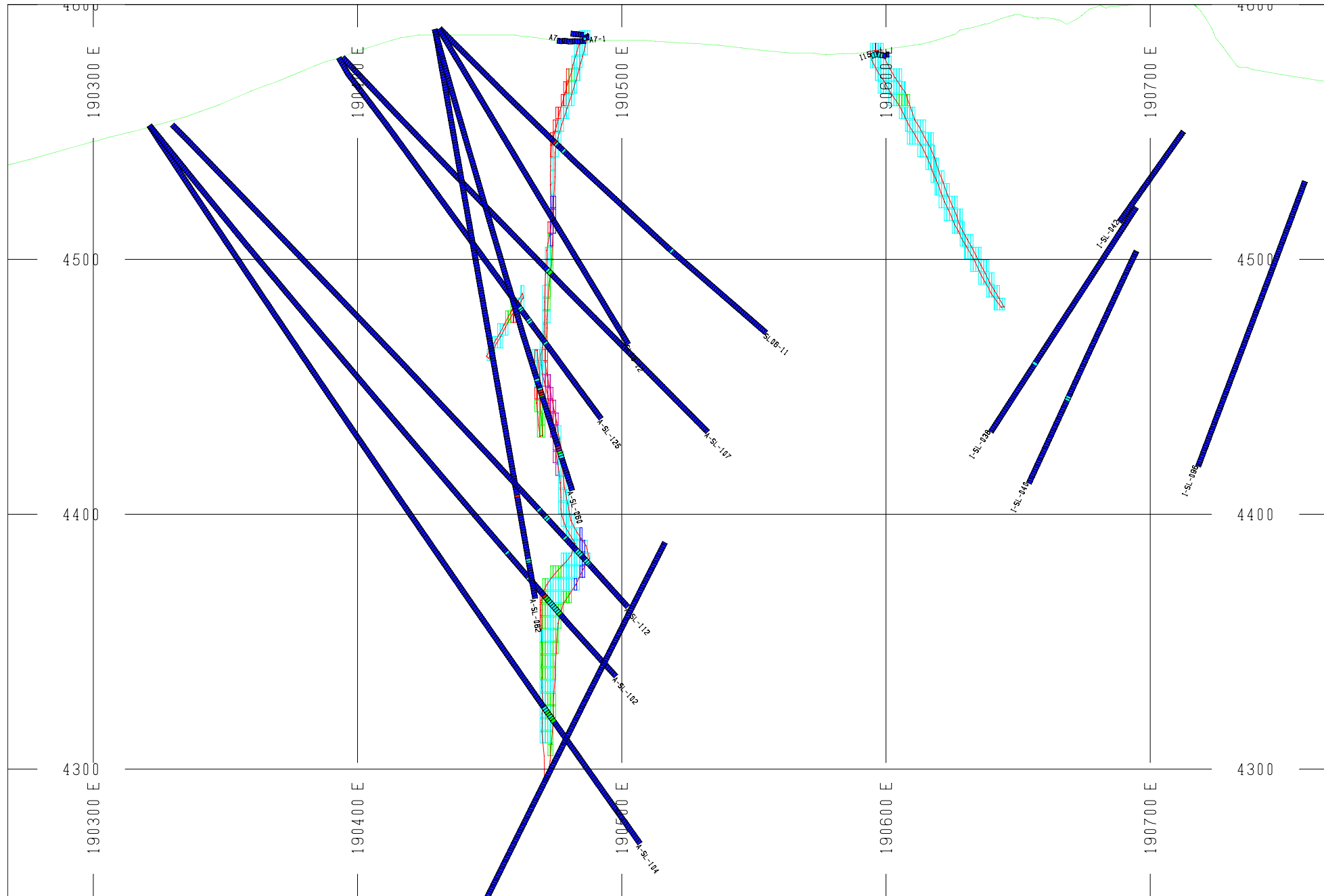

DATE:	Dec 09, 2008
SCALE:	1: 2000
FILE:	Section 1800.pdf

San Luis Project, Peru

Gold Cross Section

Section 1800 - View Looking N15W

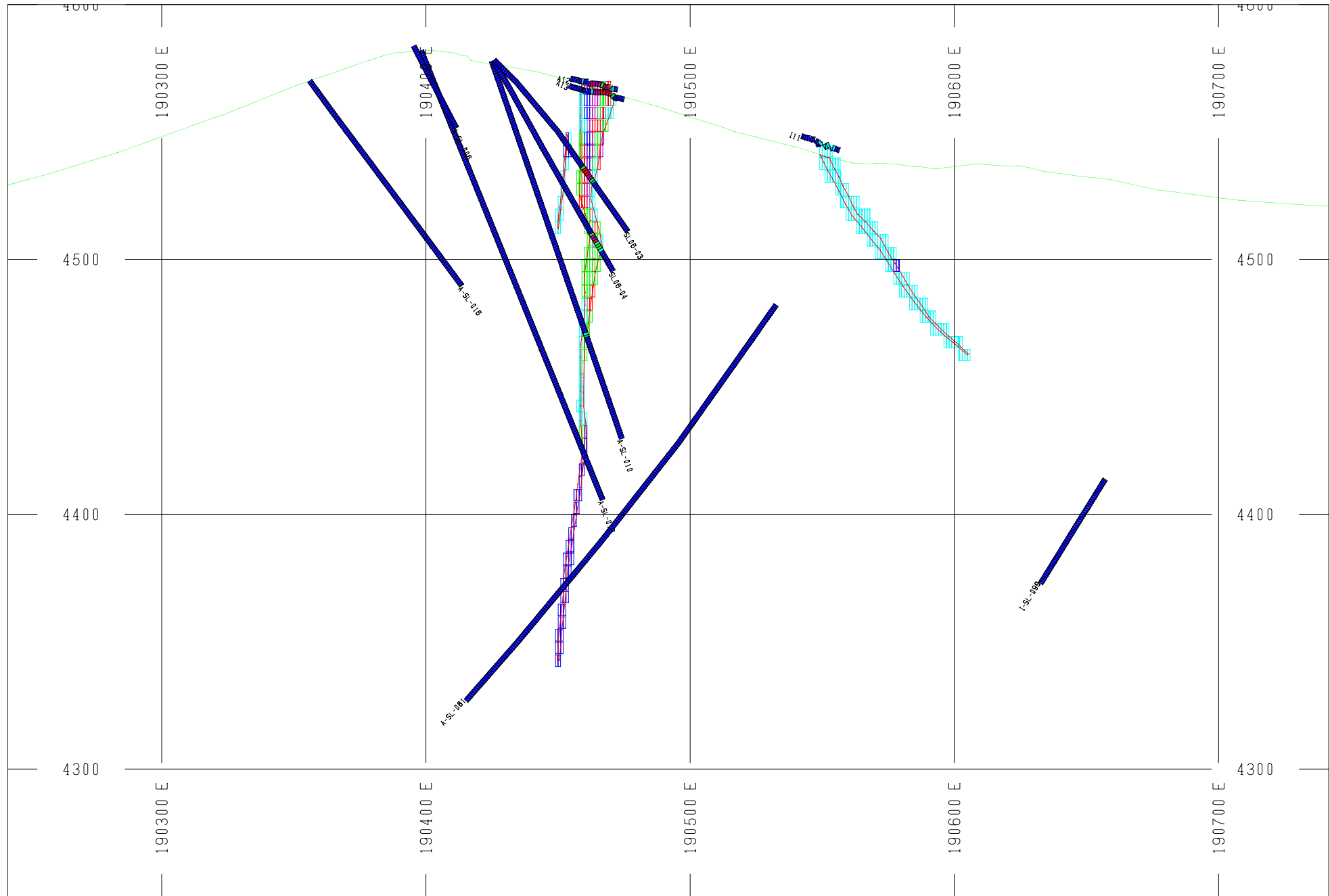

<p>1 : 2000</p>	<p>Au (g/t)</p> <ul style="list-style-type: none"> ■ < 0.50 ■ ≥ 0.50 ■ ≥ 6.00 ■ ≥ 15.00 ■ ≥ 30.00 	<p>Resource Modeling Inc. Tucson, AZ USA</p>	DATE: Dec 09, 2008	<p>San Luis Project, Peru</p> <p>Gold Cross Section</p> <p>Section 1900 - View Looking N15W</p>
			SCALE: 1: 2000	
			FILE: Section 1900.pdf	

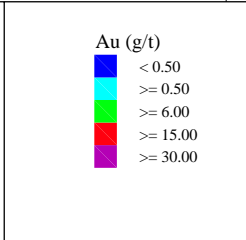
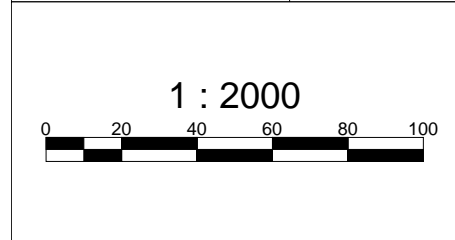
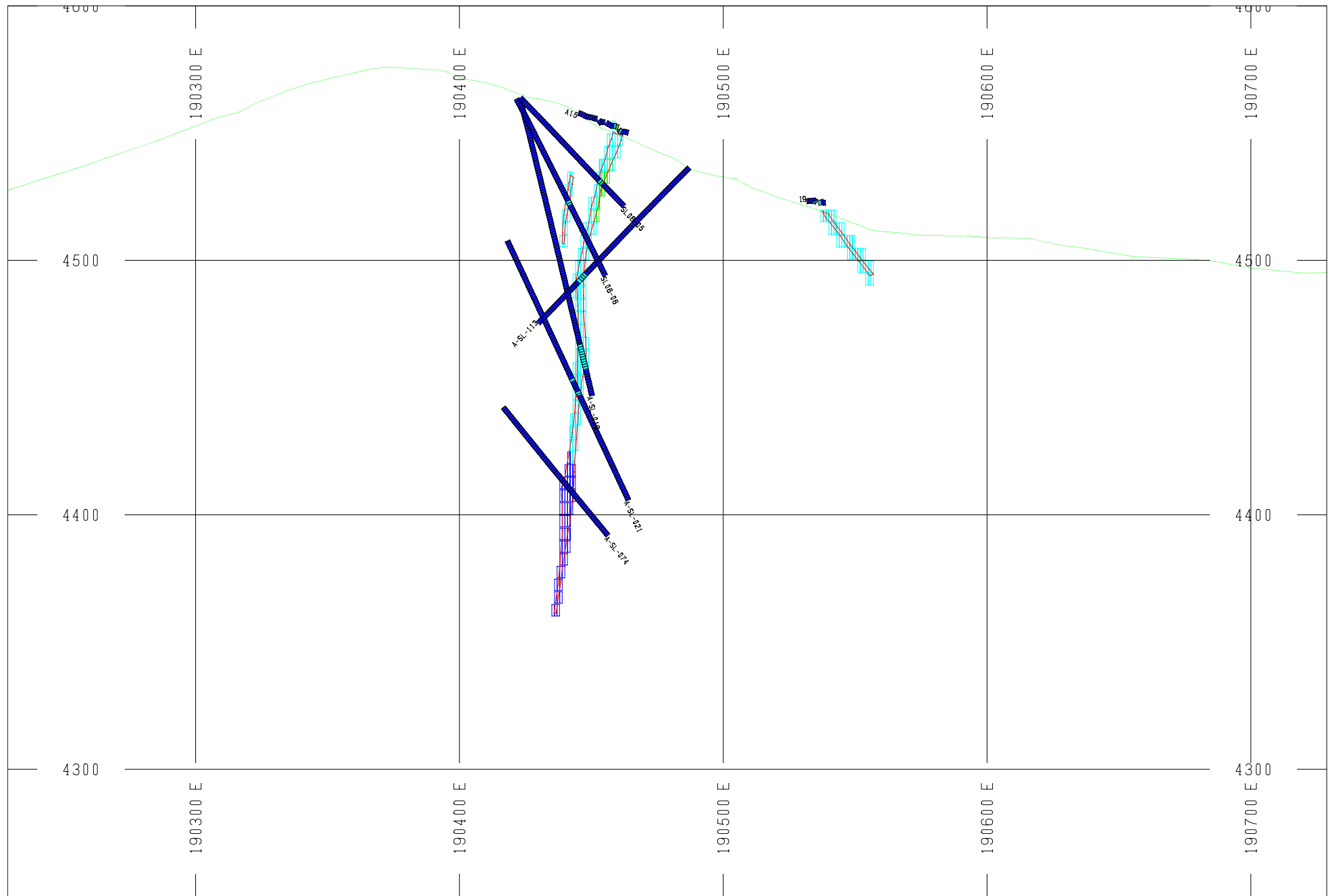

DATE:	Dec 09, 2008
SCALE:	1: 2000
FILE:	Section 1950.pdf

San Luis Project, Peru

Gold Cross Section

Section 1950 - View Looking N15W

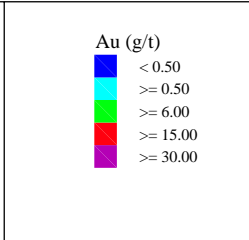
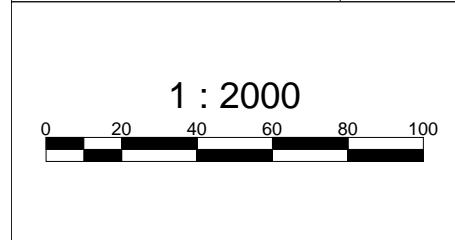
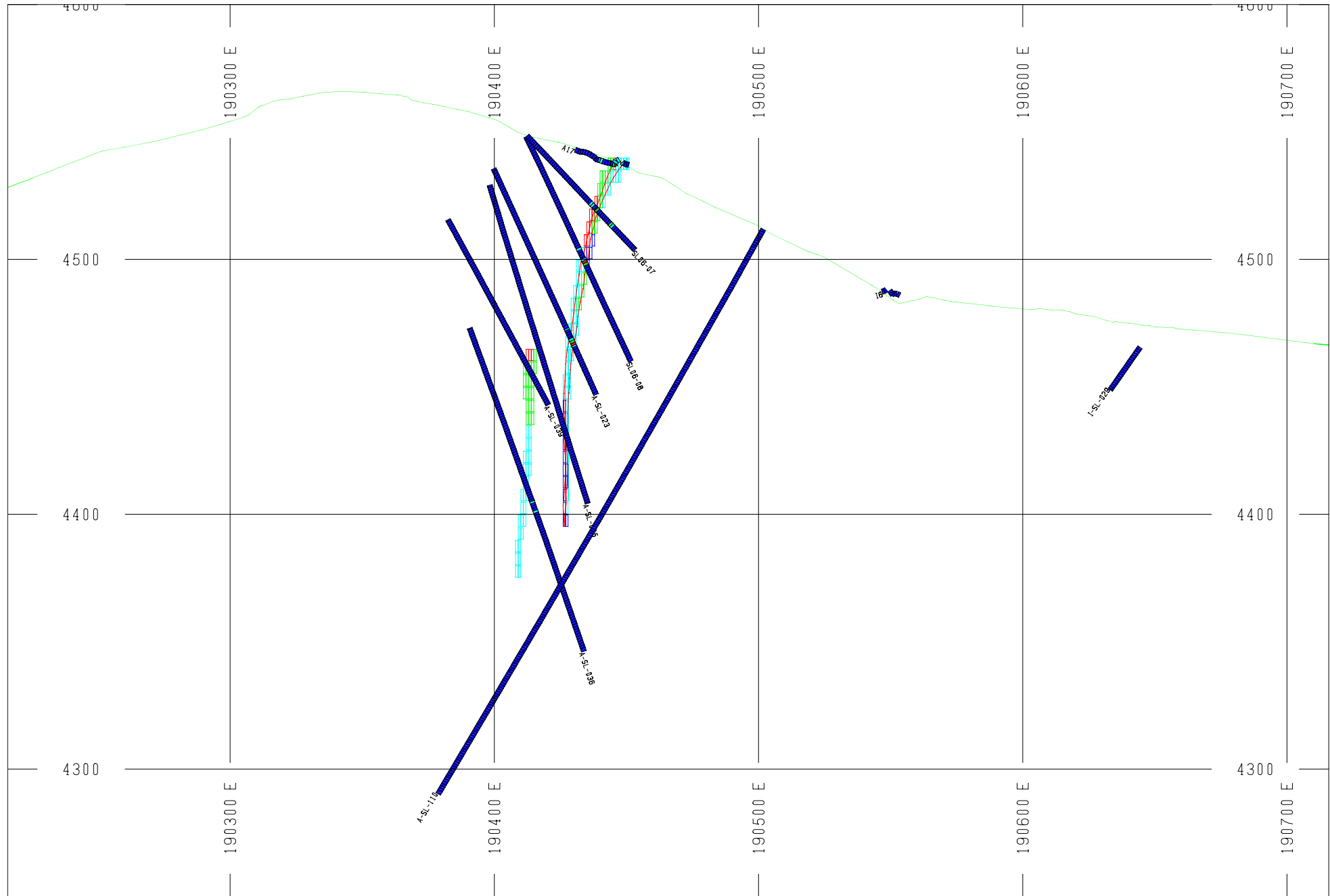

DATE:	Dec 09, 2008
SCALE:	1: 2000
FILE:	Section 2000.pdf

San Luis Project, Peru

Gold Cross Section

Section 2000 - View Looking N15W

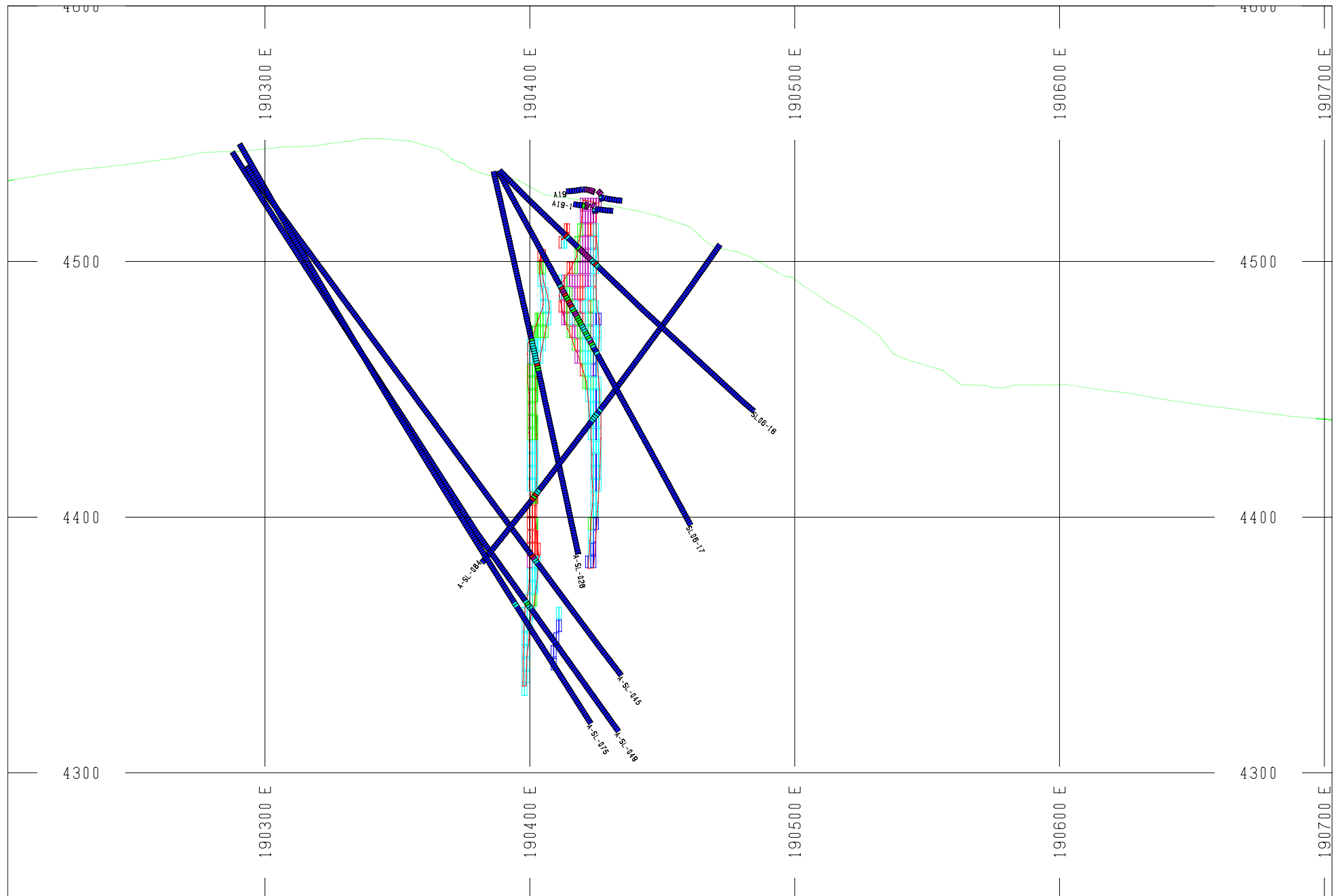

<p>1 : 2000</p>	<p>Au (g/t)</p> <ul style="list-style-type: none"> ■ < 0.50 ■ ≥ 0.50 ■ ≥ 6.00 ■ ≥ 15.00 ■ ≥ 30.00 	<p>Resource Modeling Inc. Tucson, AZ USA</p>	DATE: Dec 09, 2008	<p>San Luis Project, Peru</p> <hr/> <p>Gold Cross Section</p> <hr/> <p>Section 2050 - View Looking N15W</p>
			SCALE: 1: 2000	
			FILE: Section 2050.pdf	

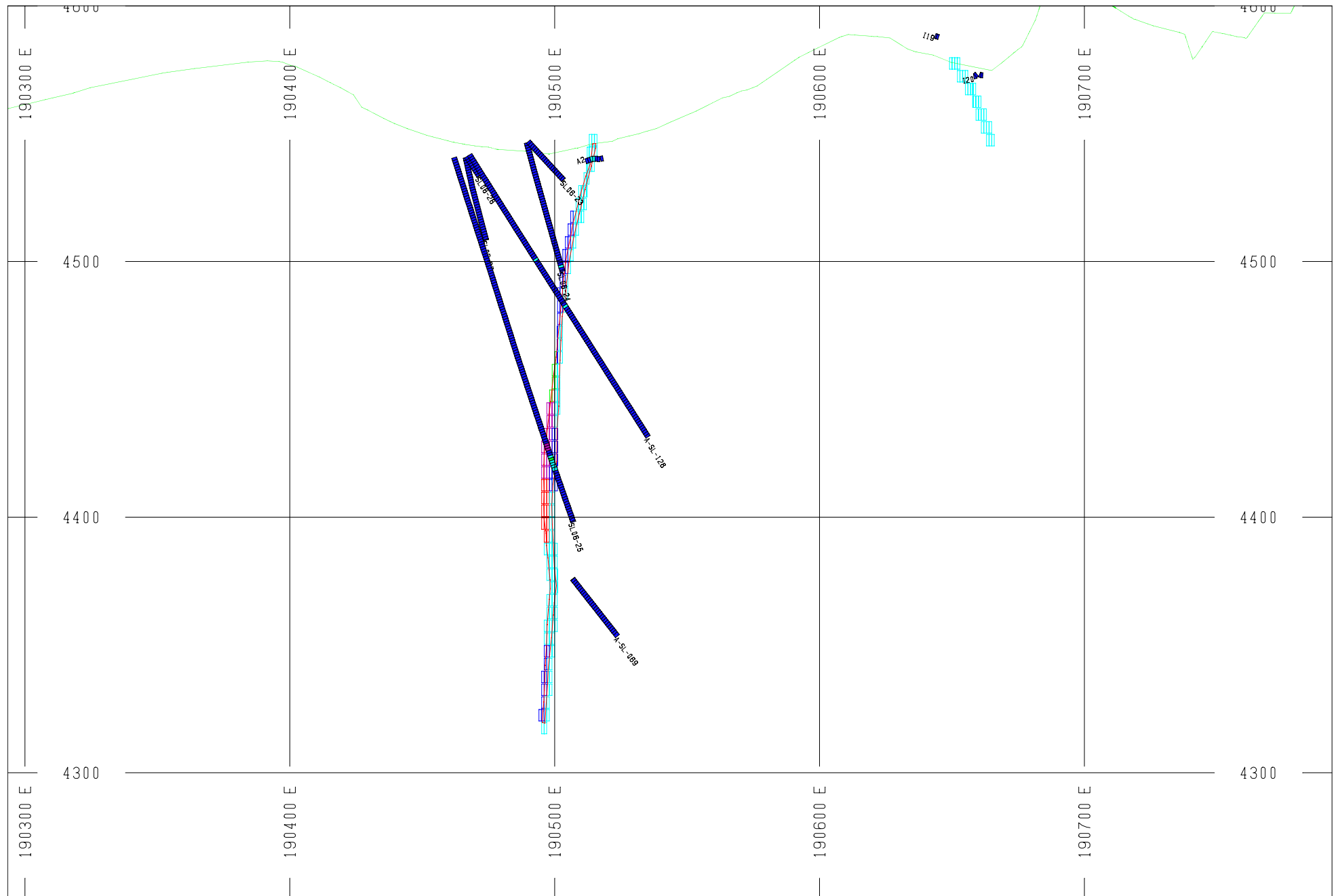

	<p>Au (g/t)</p> <ul style="list-style-type: none"> ■ < 0.50 ■ >= 0.50 ■ >= 6.00 ■ >= 15.00 ■ >= 30.00 		DATE: Dec 09, 2008	<p>San Luis Project, Peru</p> <p>Gold Cross Section</p> <p>Section 1700 - View Looking N15W</p>
			SCALE: 1: 2000	
			FILE: Section 1700.pdf	

**Updated Mineral Resource Estimate San Luis Project,
Ancash Department, Perú
January 9, 2009**

APPENDIX 4: Silver Cross Sections

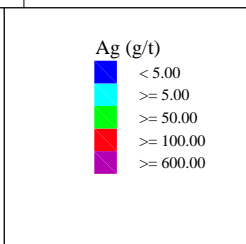
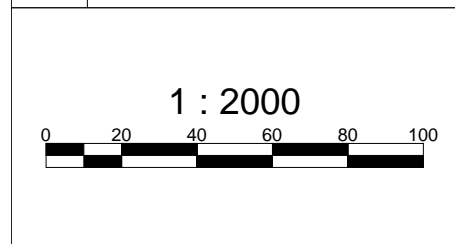
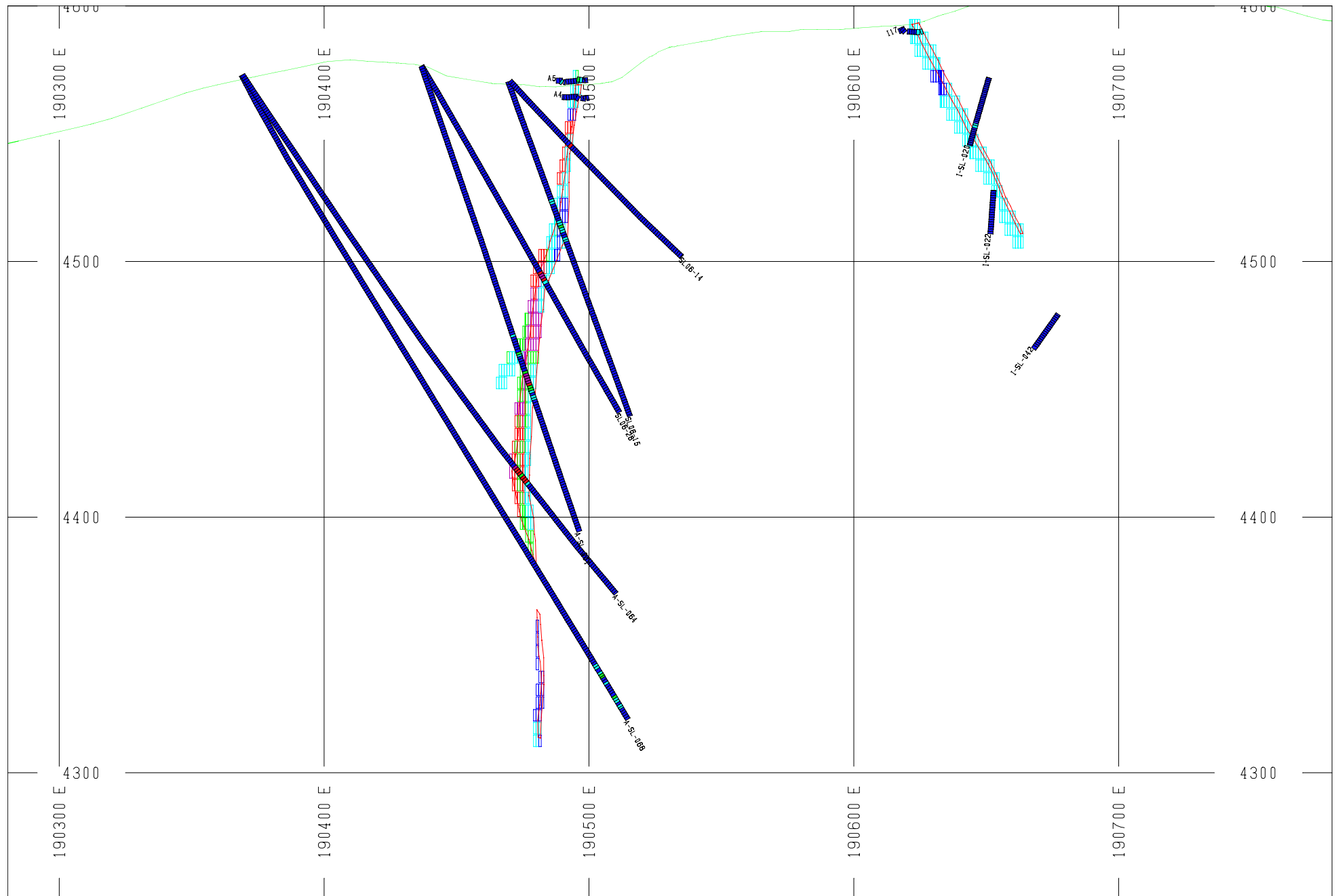

DATE:	Dec 09, 2008
SCALE:	1: 2000
FILE:	Section 1750.pdf

San Luis Project, Peru

Silver Cross Section

Section 1750 - View Looking N15W

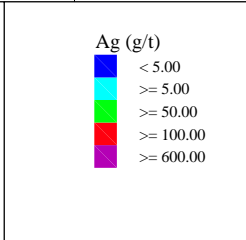
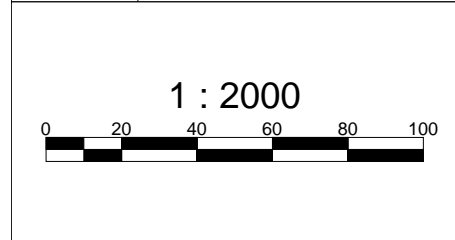
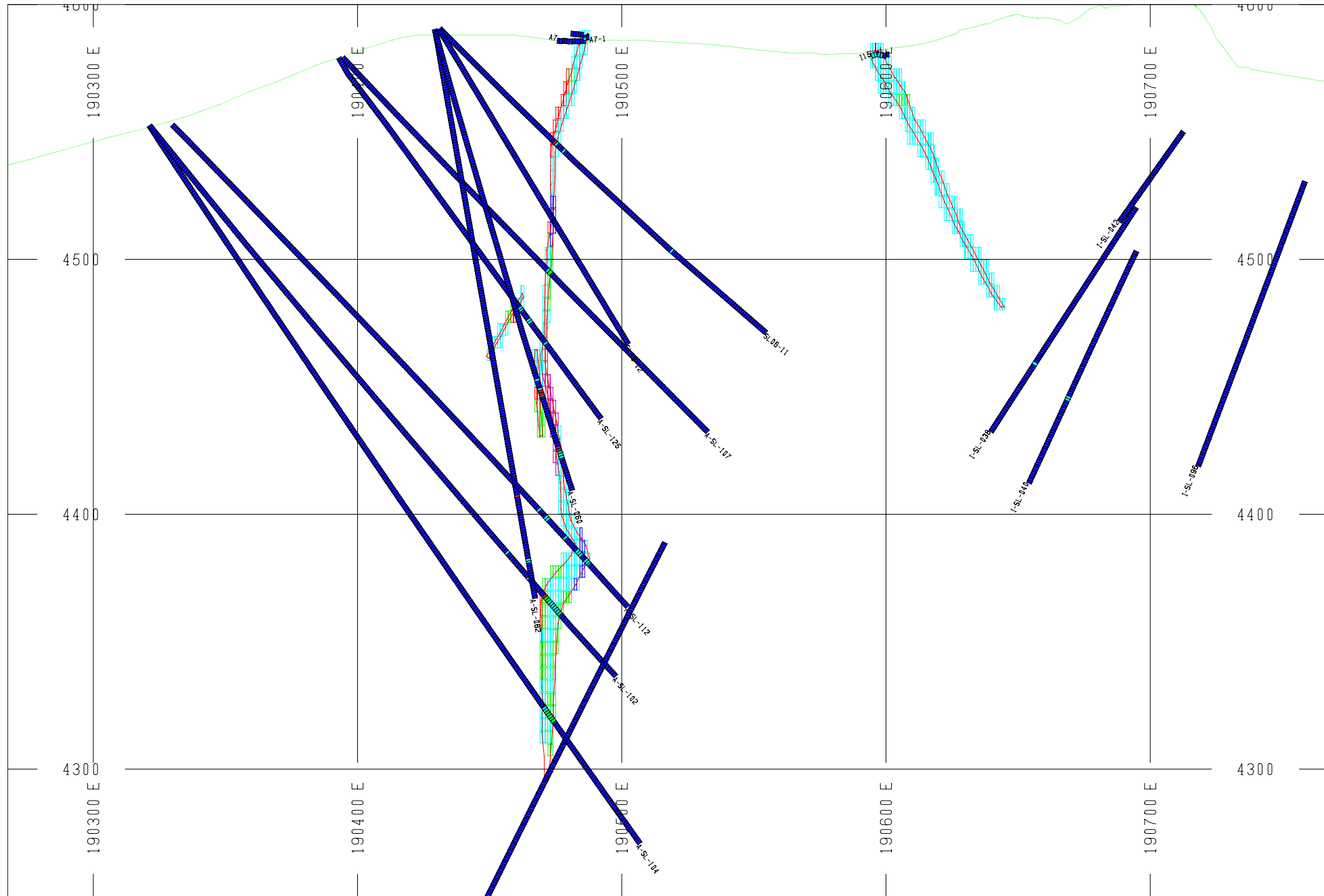

DATE:	Dec 09, 2008
SCALE:	1: 2000
FILE:	Section 1800.pdf

San Luis Project, Peru

Silver Cross Section

Section 1800 - View Looking N15W

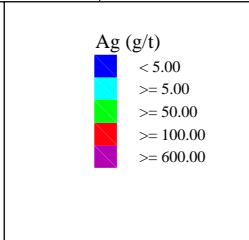
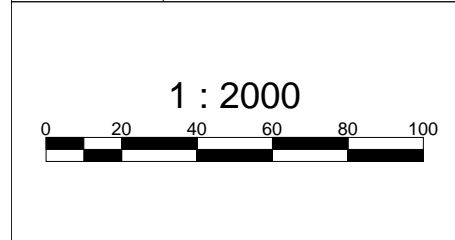
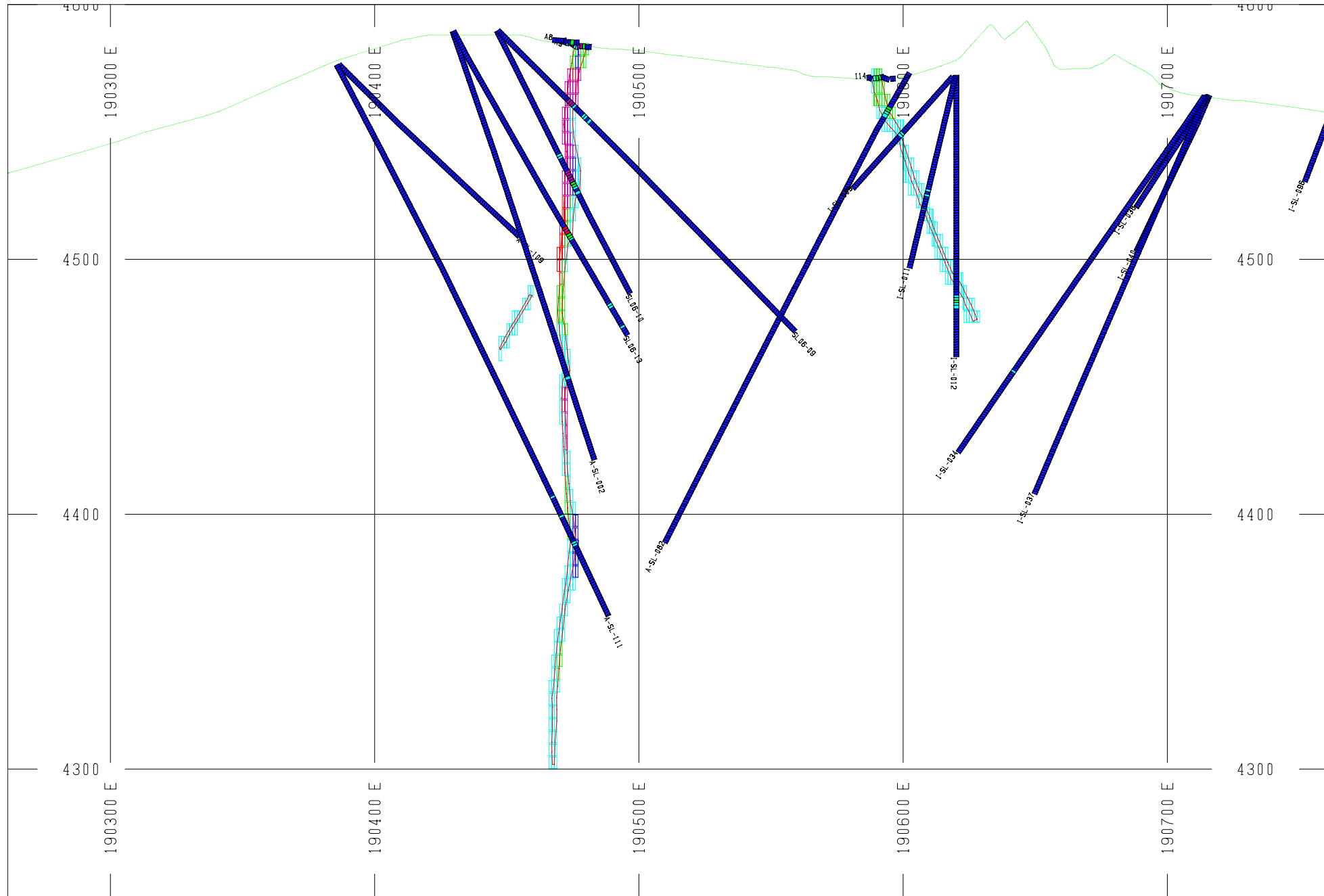

DATE:	Dec 09, 2008
SCALE:	1: 2000
FILE:	Section 1825.pdf

San Luis Project, Peru
Silver Cross Section
Section 1825 - View Looking N15W

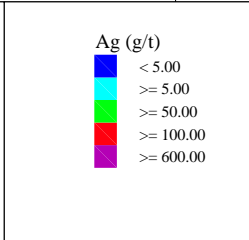
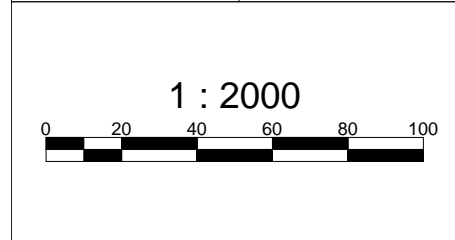
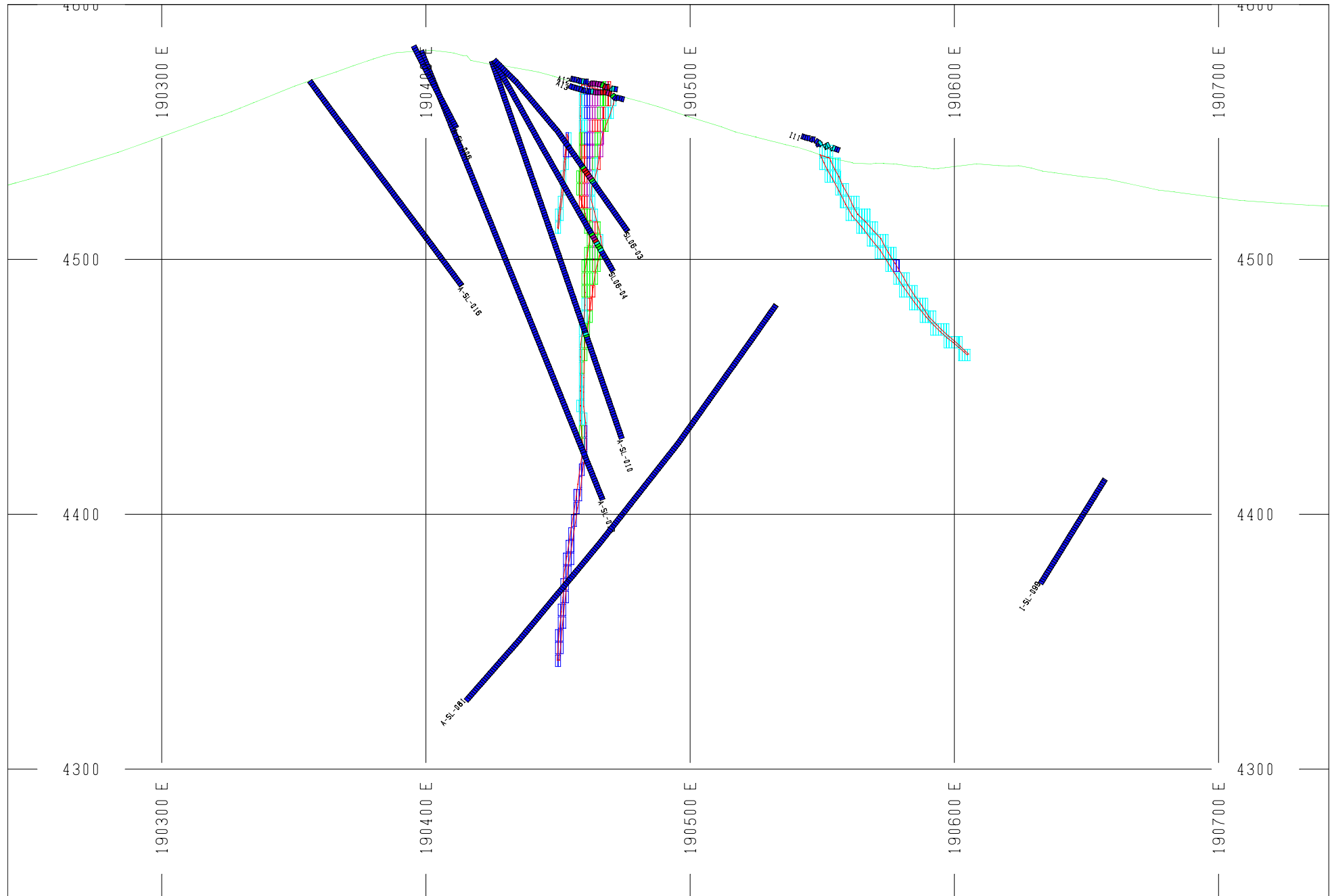

DATE:	Dec 09, 2008
SCALE:	1: 2000
FILE:	Section 1900.pdf

San Luis Project, Peru

Silver Cross Section

Section 1900 - View Looking N15W

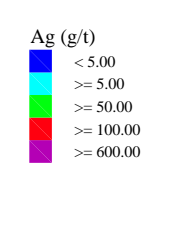
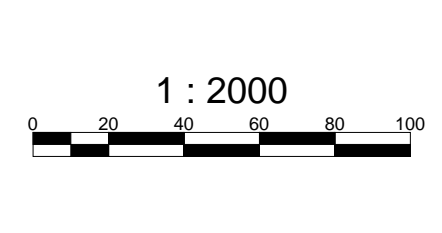
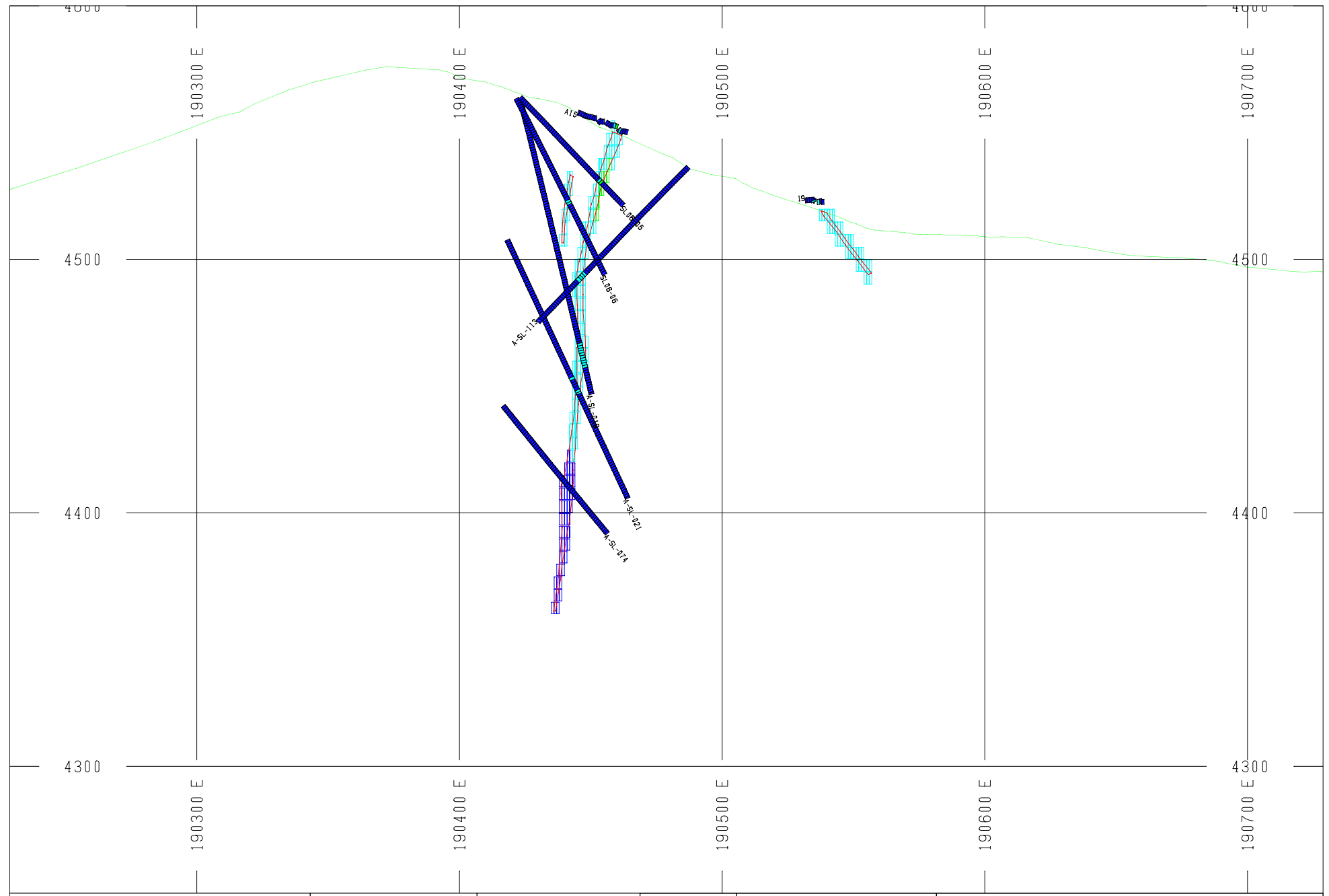

DATE:	Dec 09, 2008
SCALE:	1: 2000
FILE:	Section 1950.pdf

San Luis Project, Peru

Silver Cross Section

Section 1950 - View Looking N15W

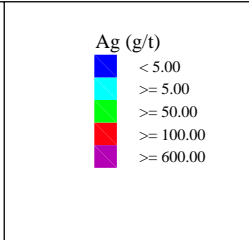
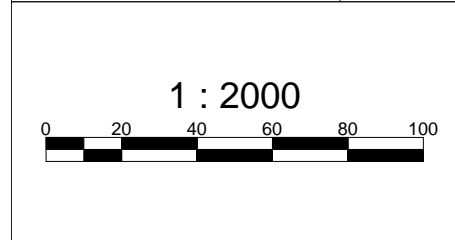
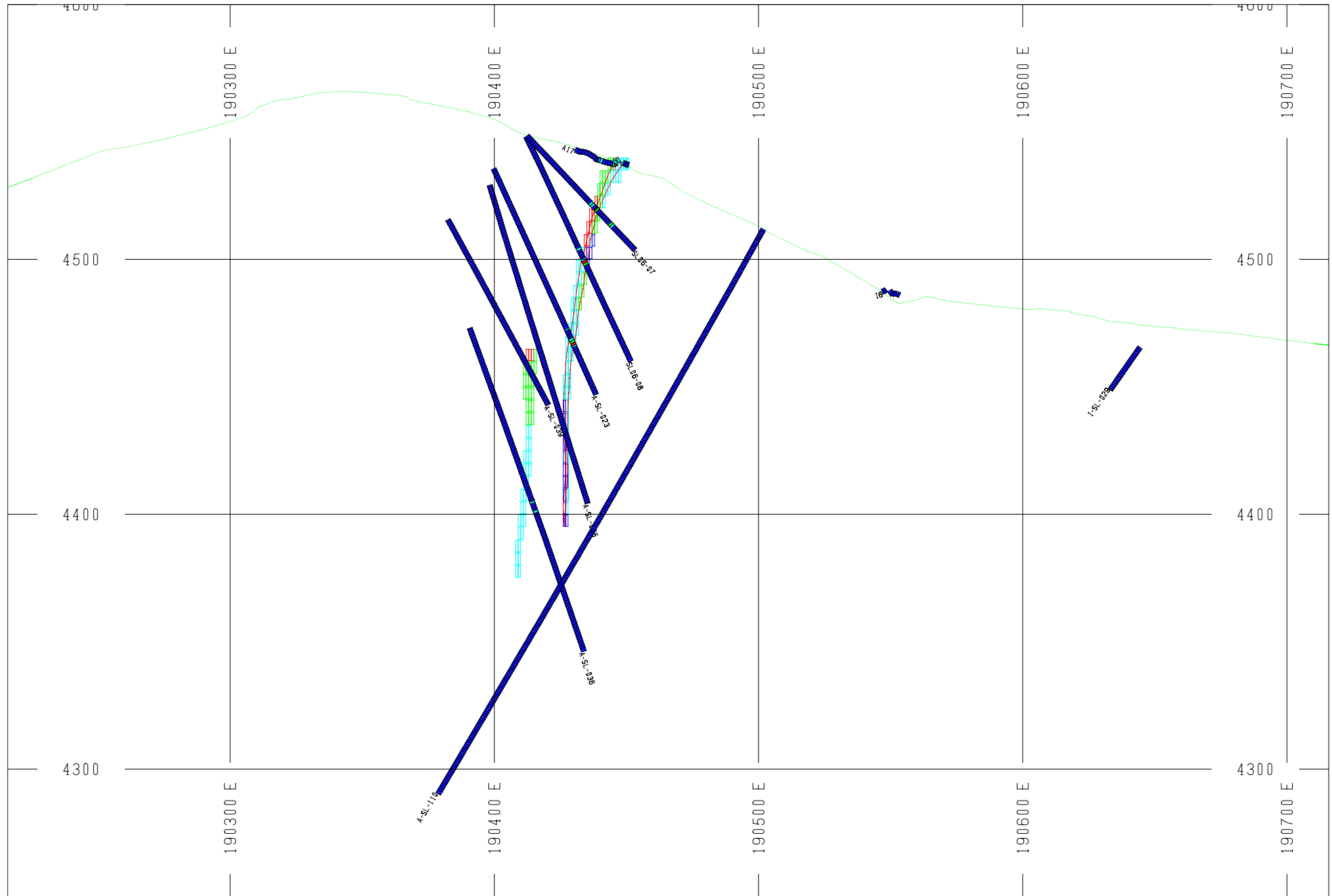

DATE:	Dec 09, 2008
SCALE:	1: 2000
FILE:	Section 2000.pdf

San Luis Project, Peru
Silver Cross Section
Section 2000 - View Looking N15W

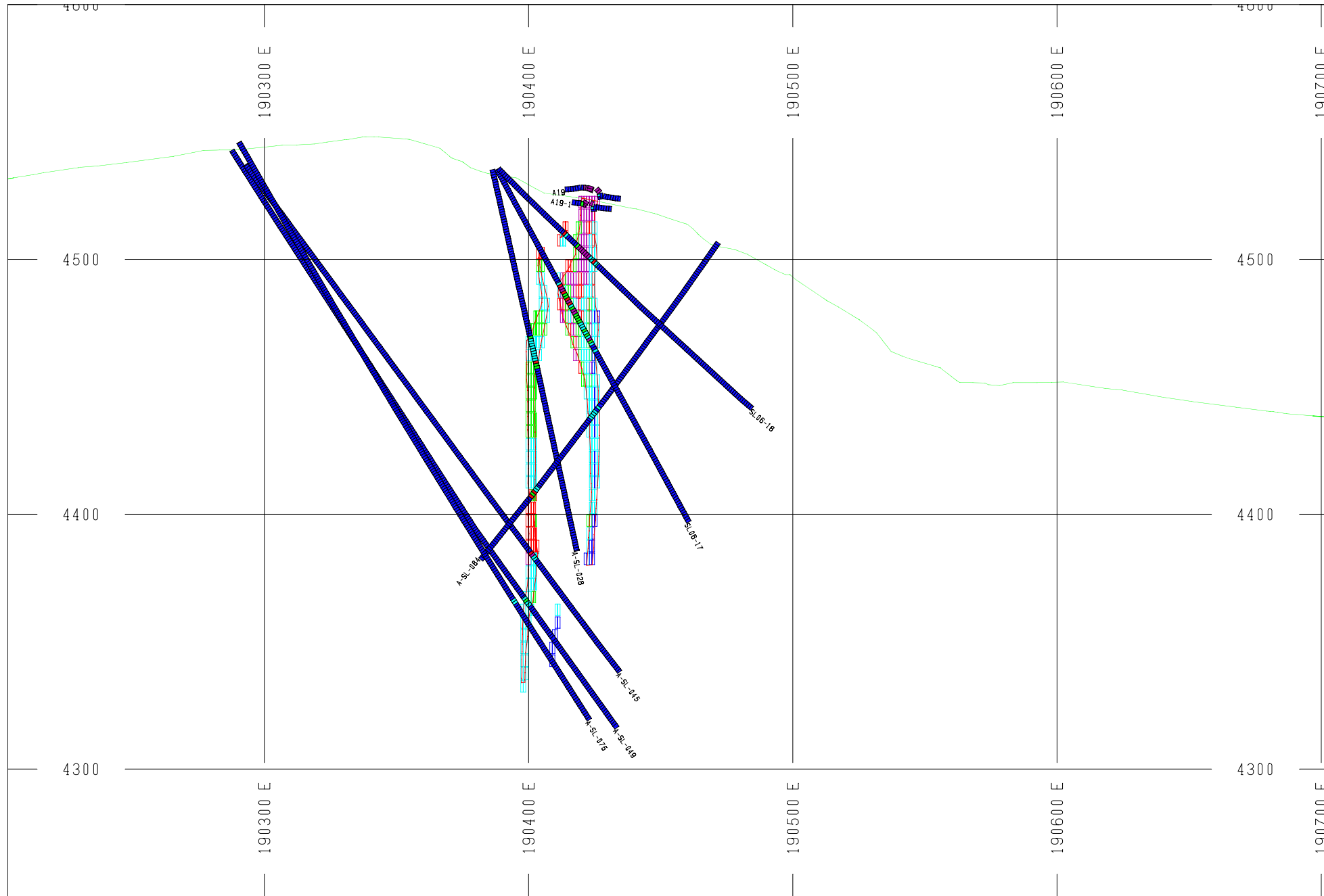

	<p>Ag (g/t)</p> <ul style="list-style-type: none"> ■ < 5.00 ■ ≥ 5.00 ■ ≥ 50.00 ■ ≥ 100.00 ■ ≥ 600.00 	<p>Resource Modeling Inc. Tucson, AZ USA</p>	DATE: Dec 09, 2008	<p>San Luis Project, Peru</p> <p>Silver Cross Section</p> <p>Section 2050 - View Looking N15W</p>
			SCALE: 1: 2000	
			FILE: Section 2050.pdf	

**Updated Mineral Resource Estimate San Luis Project,
Ancash Department, Perú
January 9, 2009**

APPENDIX 5: Gold Level Plans

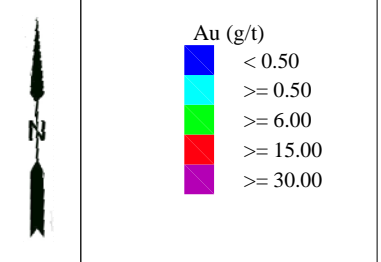
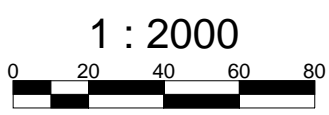
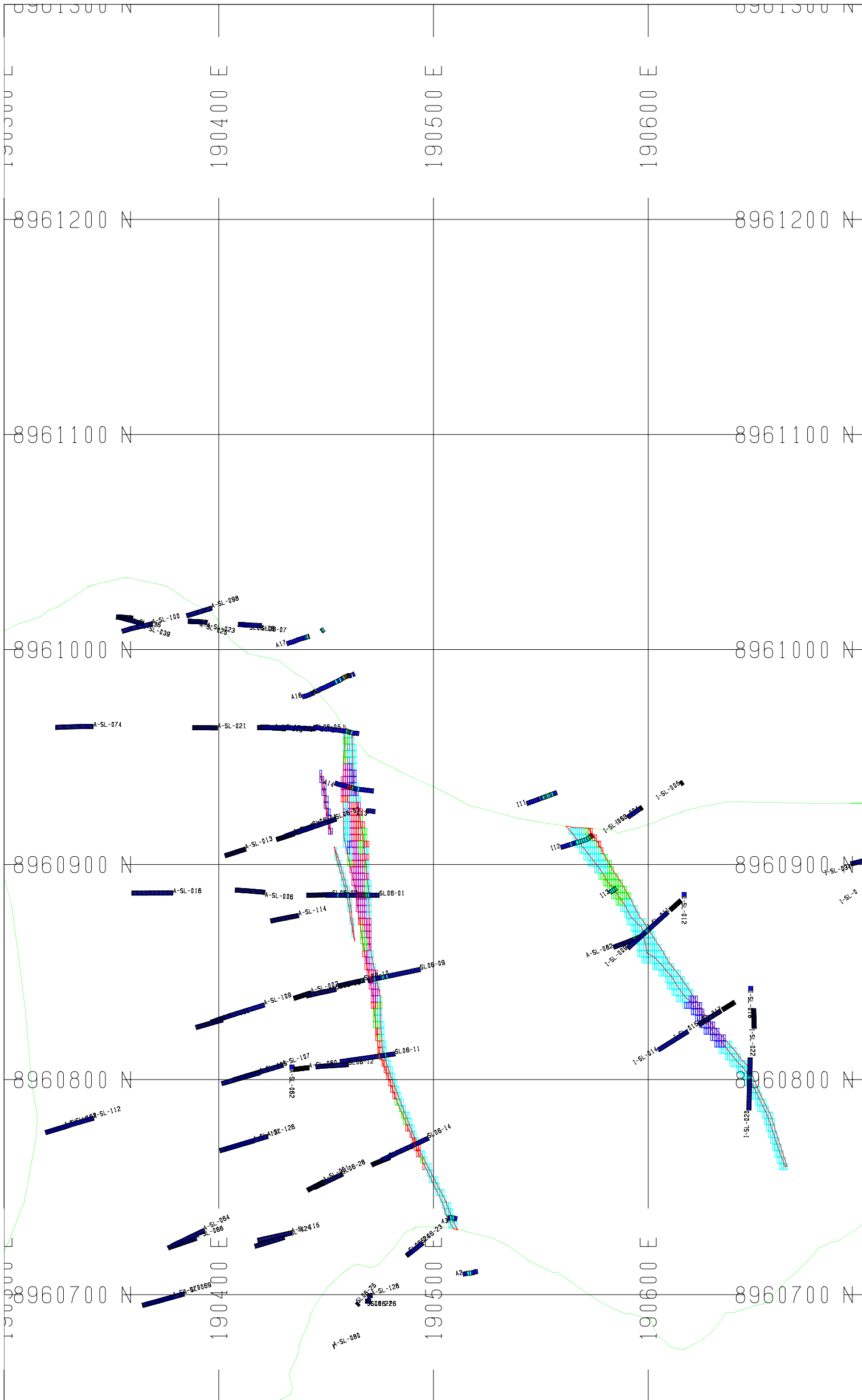

San Luis Project, Peru		
Gold Bench Level Plan		
4550 Elevation		
DATE	SCALE	FILE
Dec 09, 2008	1:2000	4550 Elevation.pdf

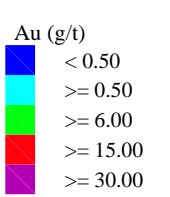
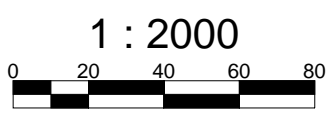
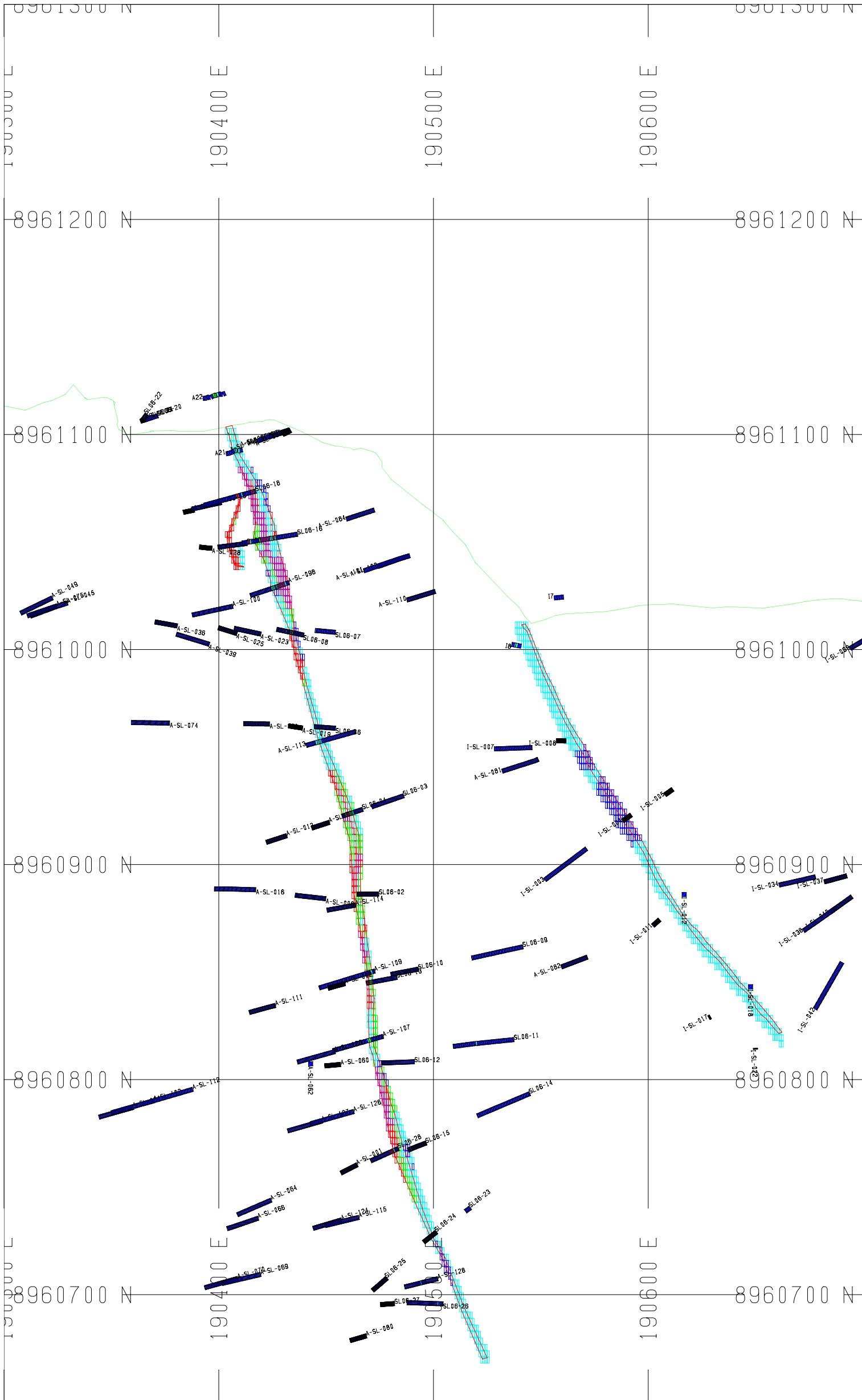

San Luis Project, Peru		
Gold Bench Level Plan		
4500 Elevation		
DATE	SCALE	FILE
Dec 09, 2008	1:2000	4500 Elevation.pdf

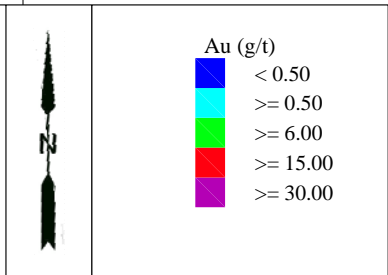
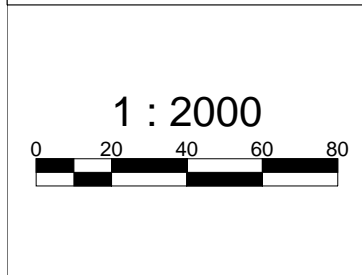
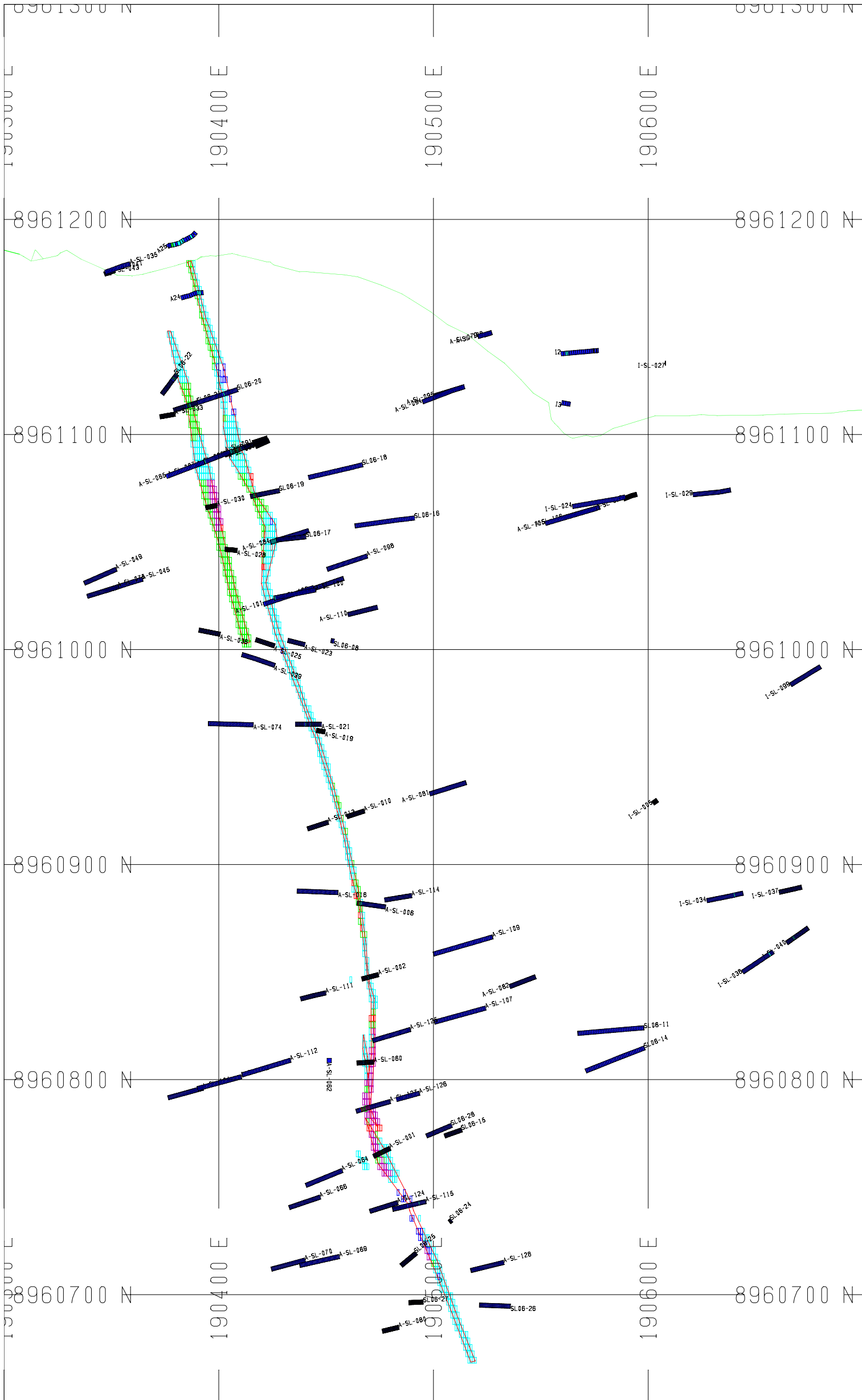

San Luis Project, Peru		
Gold Bench Level Plan		
4450 Elevation		
DATE	SCALE	FILE
Dec 09, 2008	1:2000	4450 Elevation.pdf

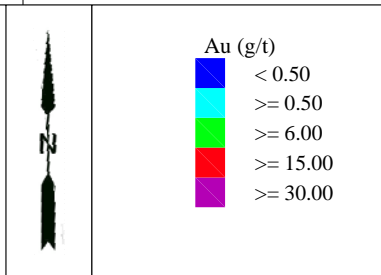
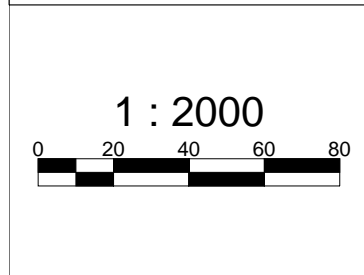
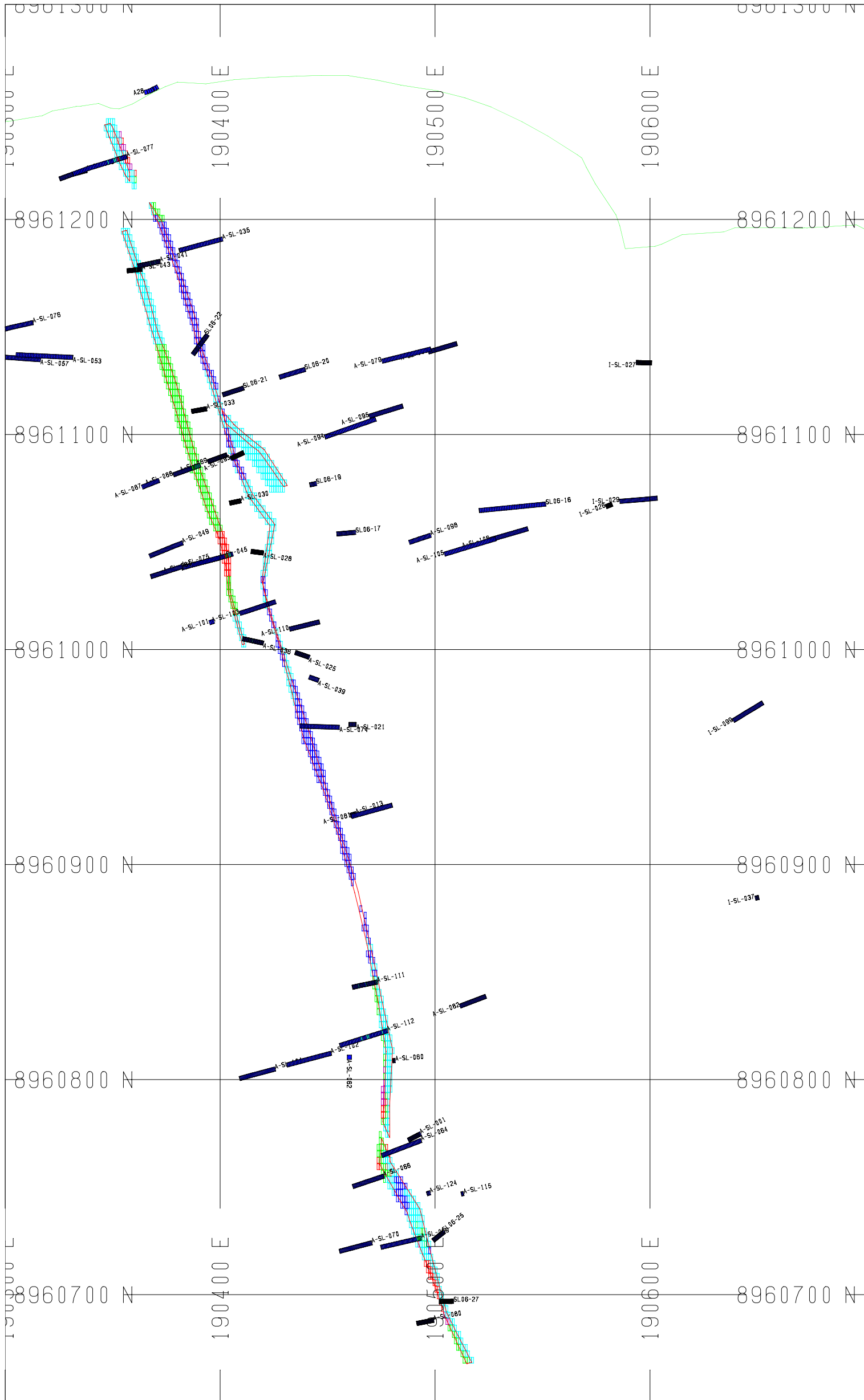

San Luis Project, Peru		
Gold Bench Level Plan		
4400 Elevation		
DATE	SCALE	FILE
Dec 09, 2008	1:2000	4400 Elevation.pdf

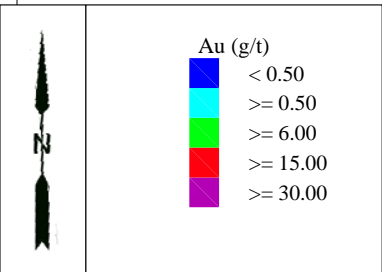
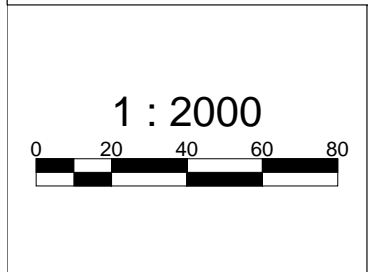
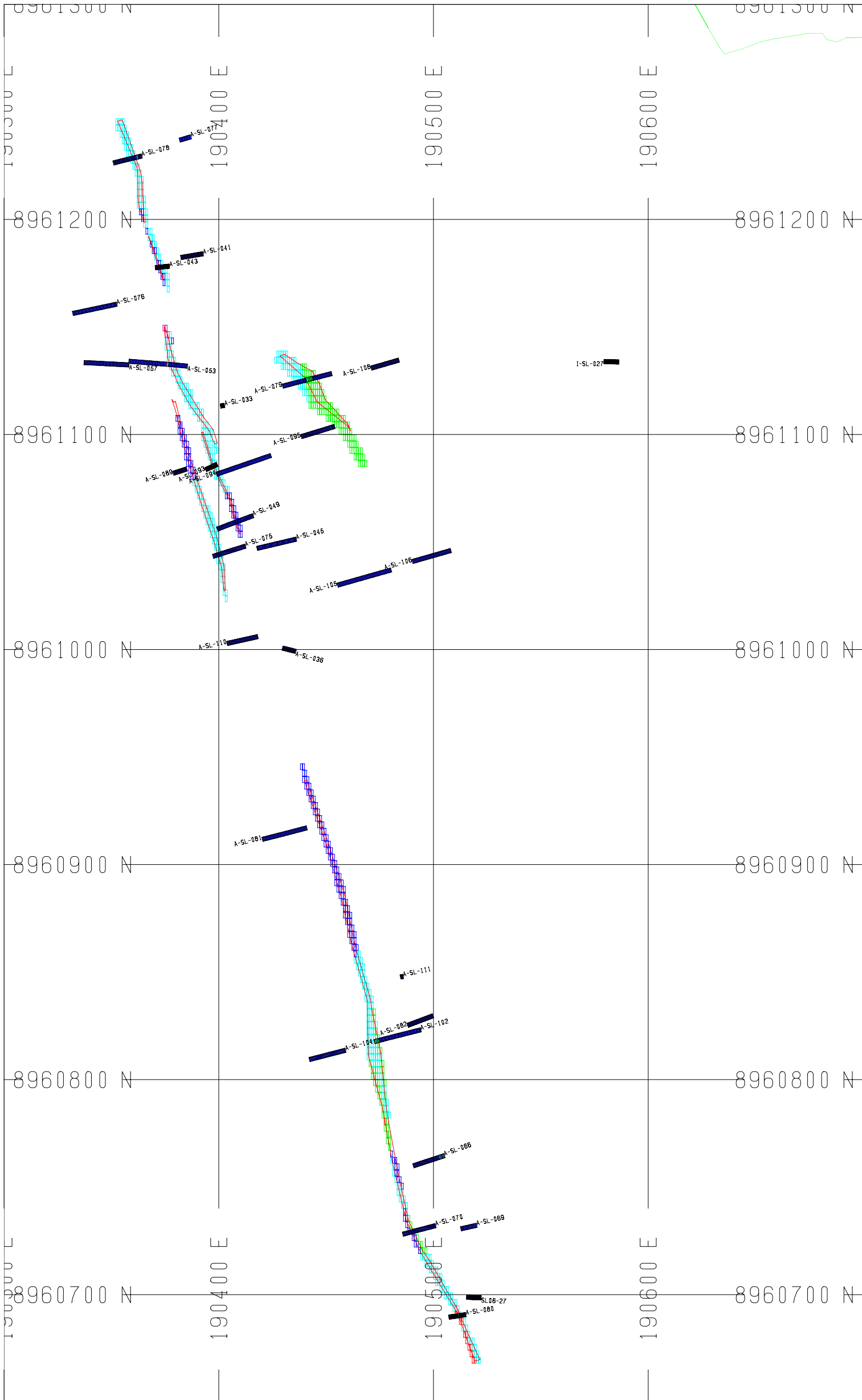

San Luis Project, Peru		
Gold Bench Level Plan		
4350 Elevation		
DATE	SCALE	FILE
Dec 09, 2008	1:2000	4350 Elevation.pdf

**Updated Mineral Resource Estimate San Luis Project,
Ancash Department, Perú
January 9, 2009**

APPENDIX 6: Silver Level Plans

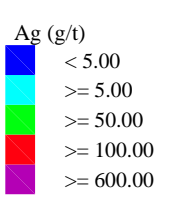
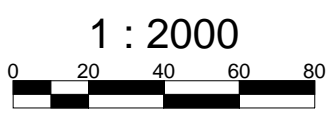
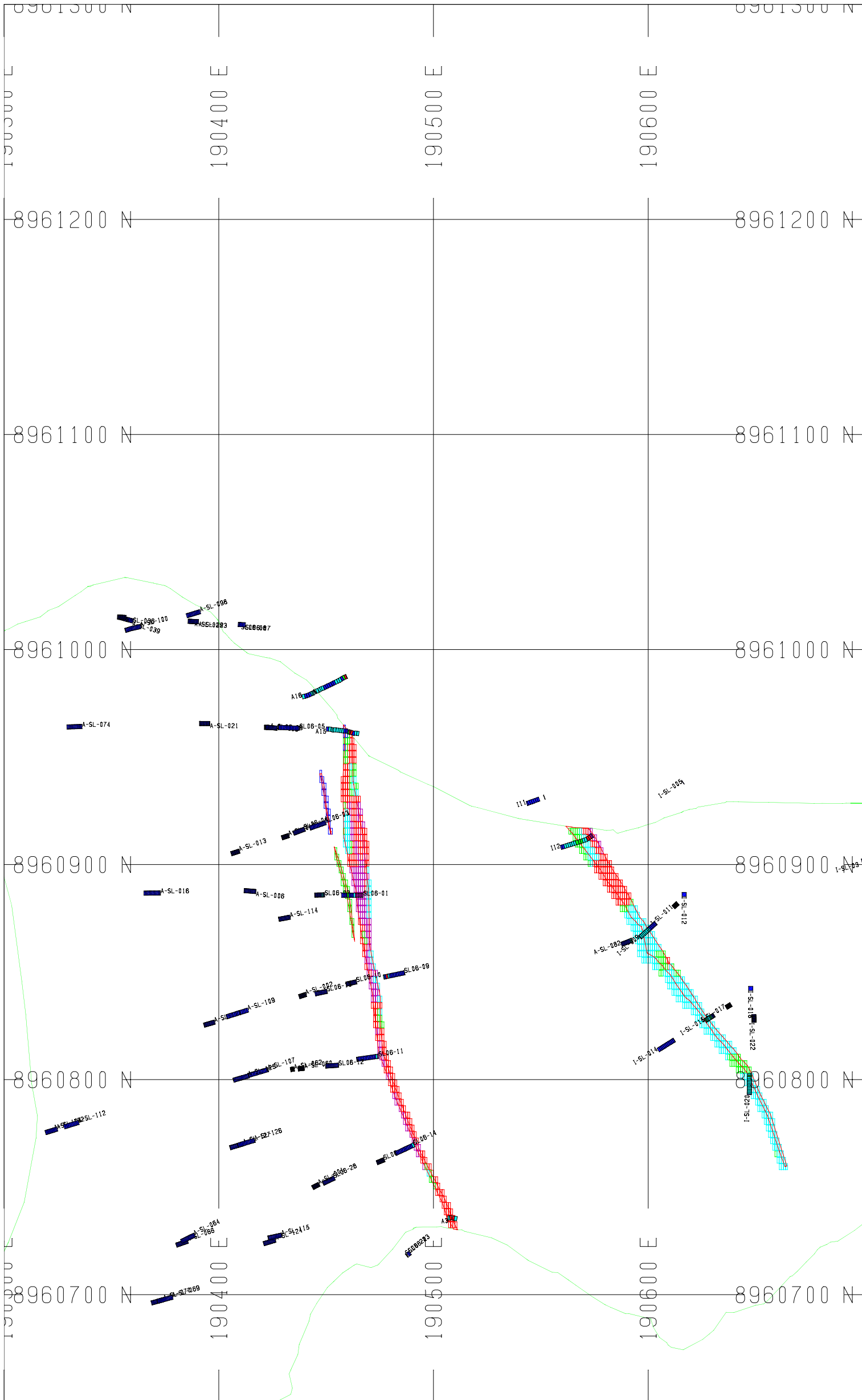

San Luis Project, Peru		
Silver Bench Level Plan		
4550 Elevation		
DATE	SCALE	FILE
Dec 09, 2008	1:2000	4550 Elevation.pdf

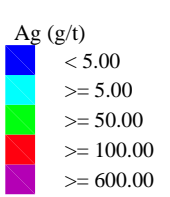
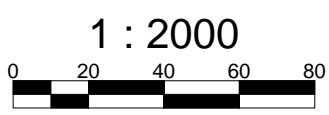
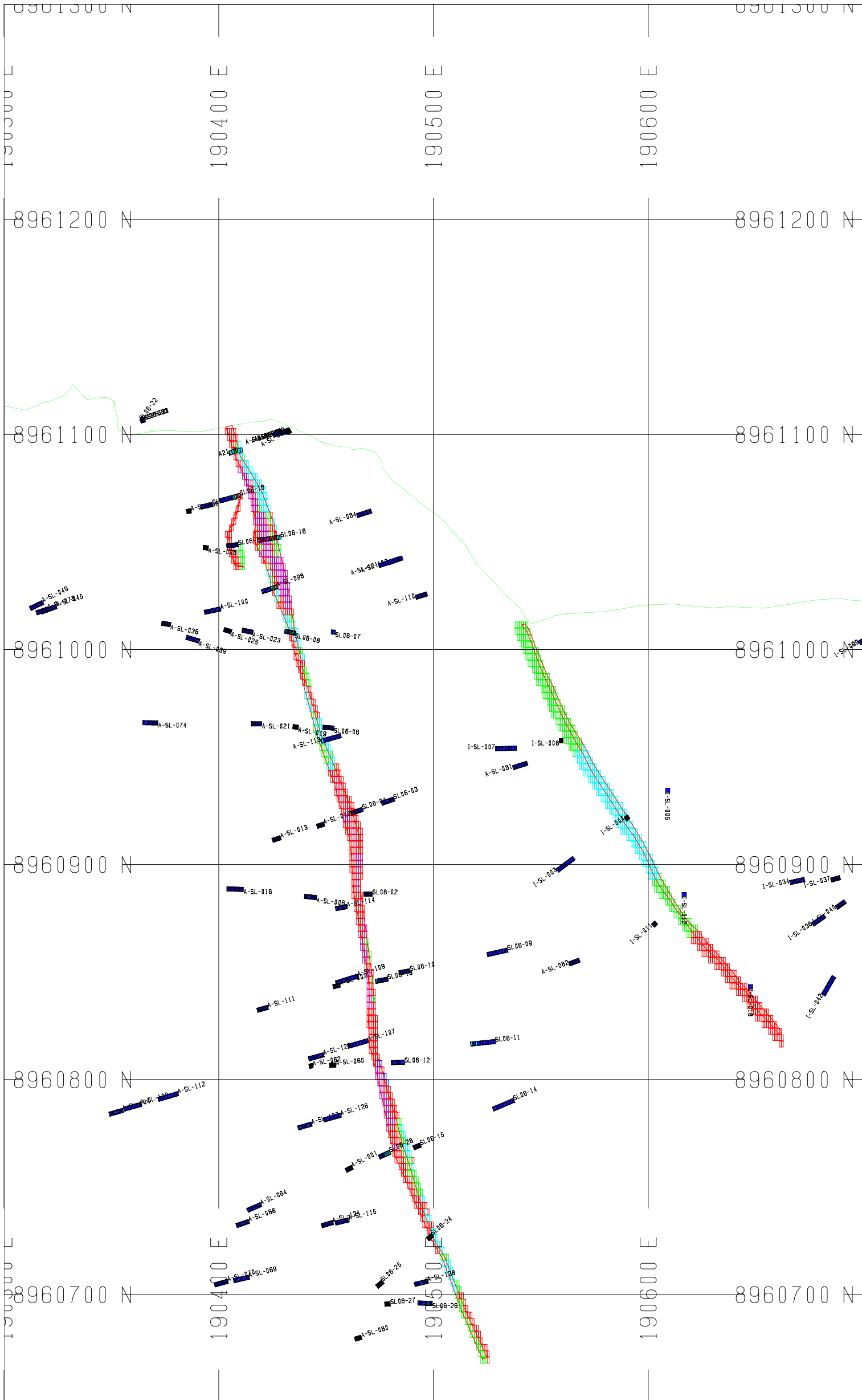

San Luis Project, Peru

Silver Bench Level Plan

4500 Elevation

DATE	SCALE	FILE
Dec 09, 2008	1:2000	4500 Elevation.pdf

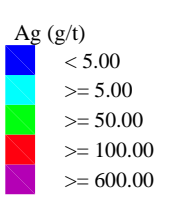
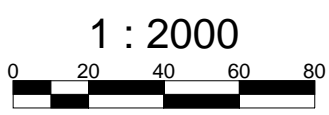
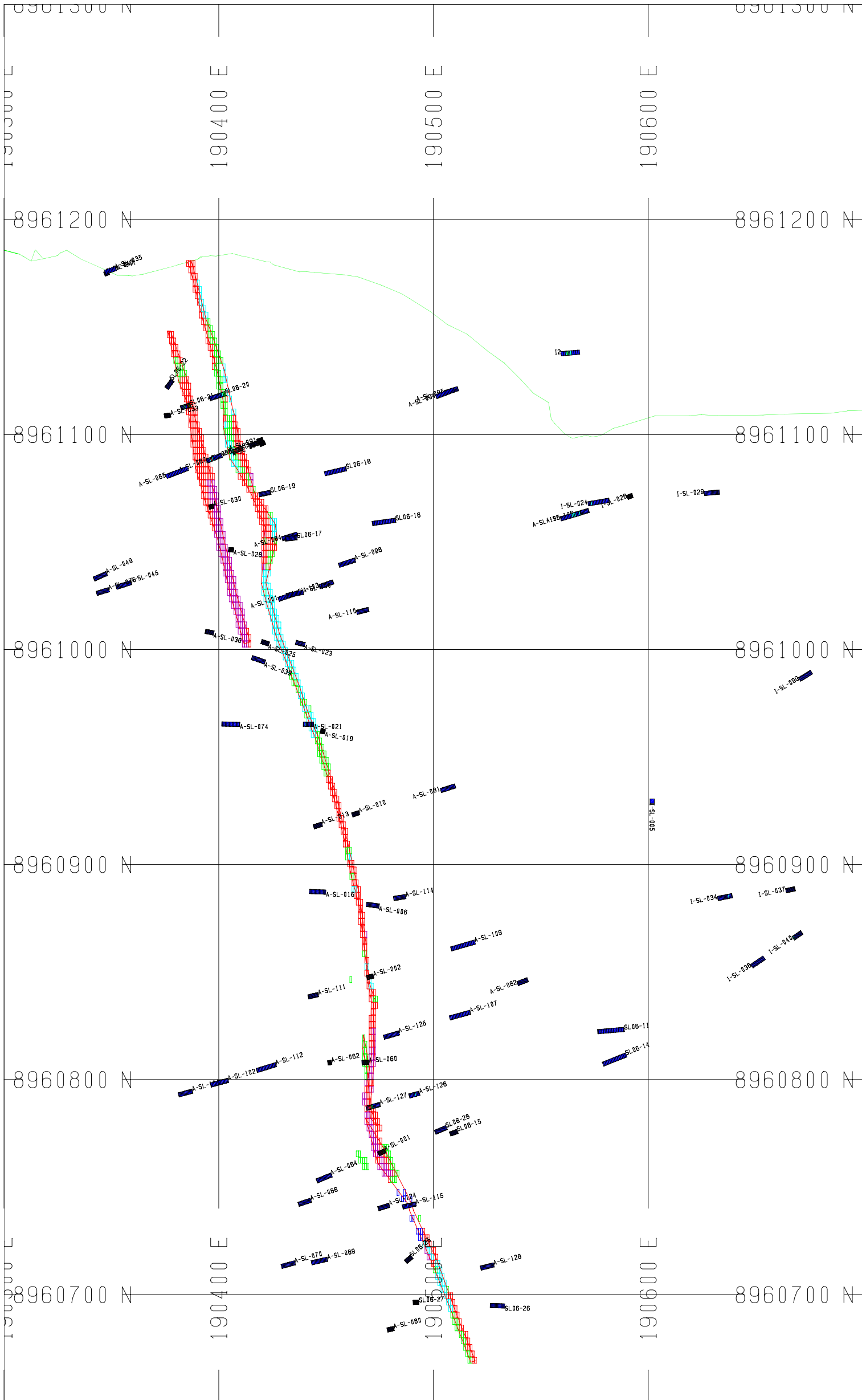

San Luis Project, Peru

Silver Bench Level Plan

4450 Elevation

DATE	SCALE	FILE
Dec 09, 2008	1:2000	4450 Elevation.pdf

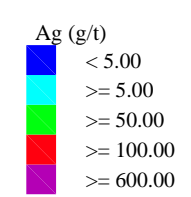
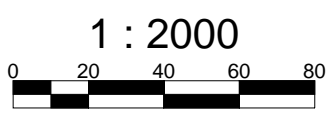
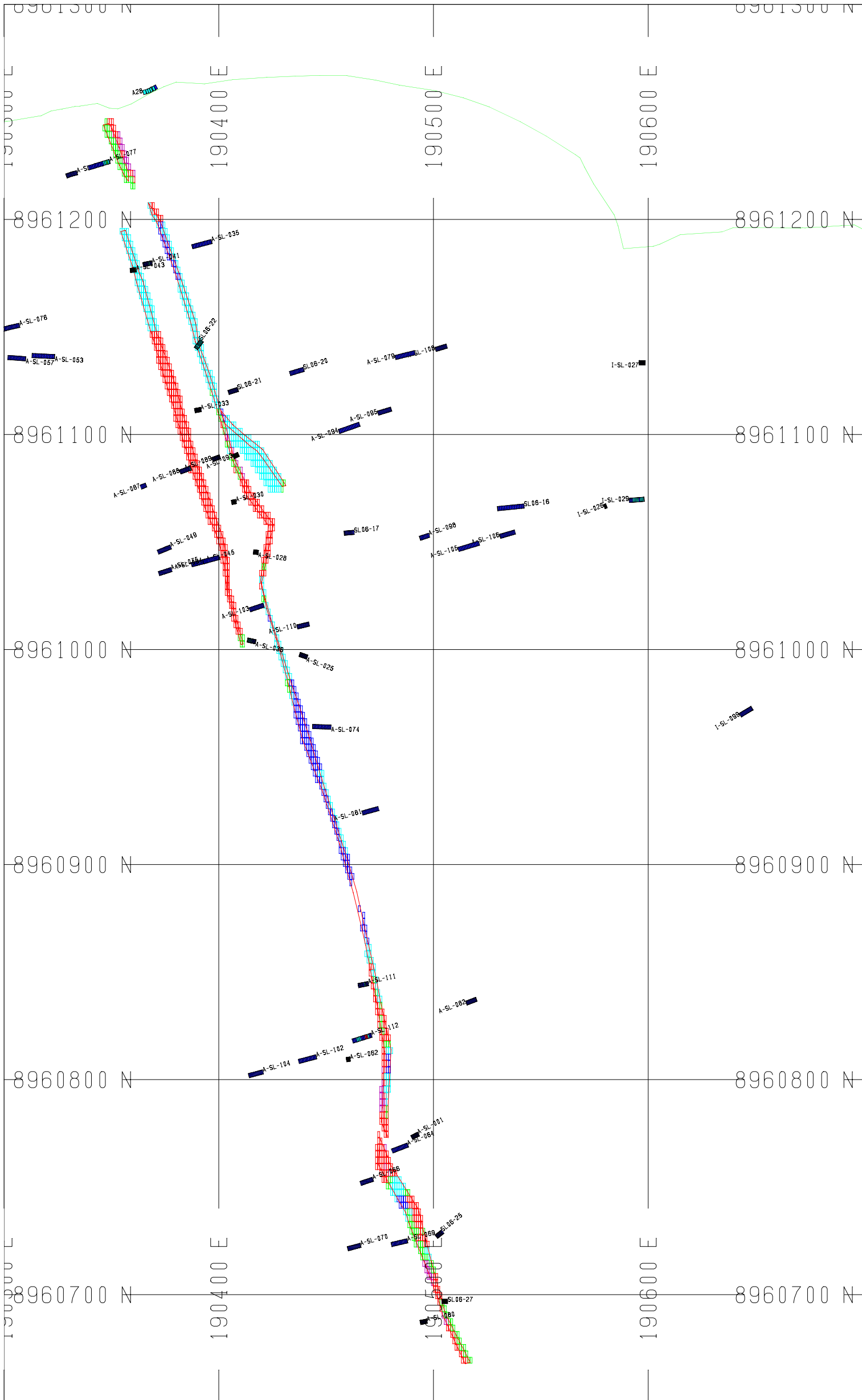

San Luis Project, Peru		
Silver Bench Level Plan		
4400 Elevation		
DATE	SCALE	FILE
Dec 09, 2008	1:2000	4400 Elevation.pdf

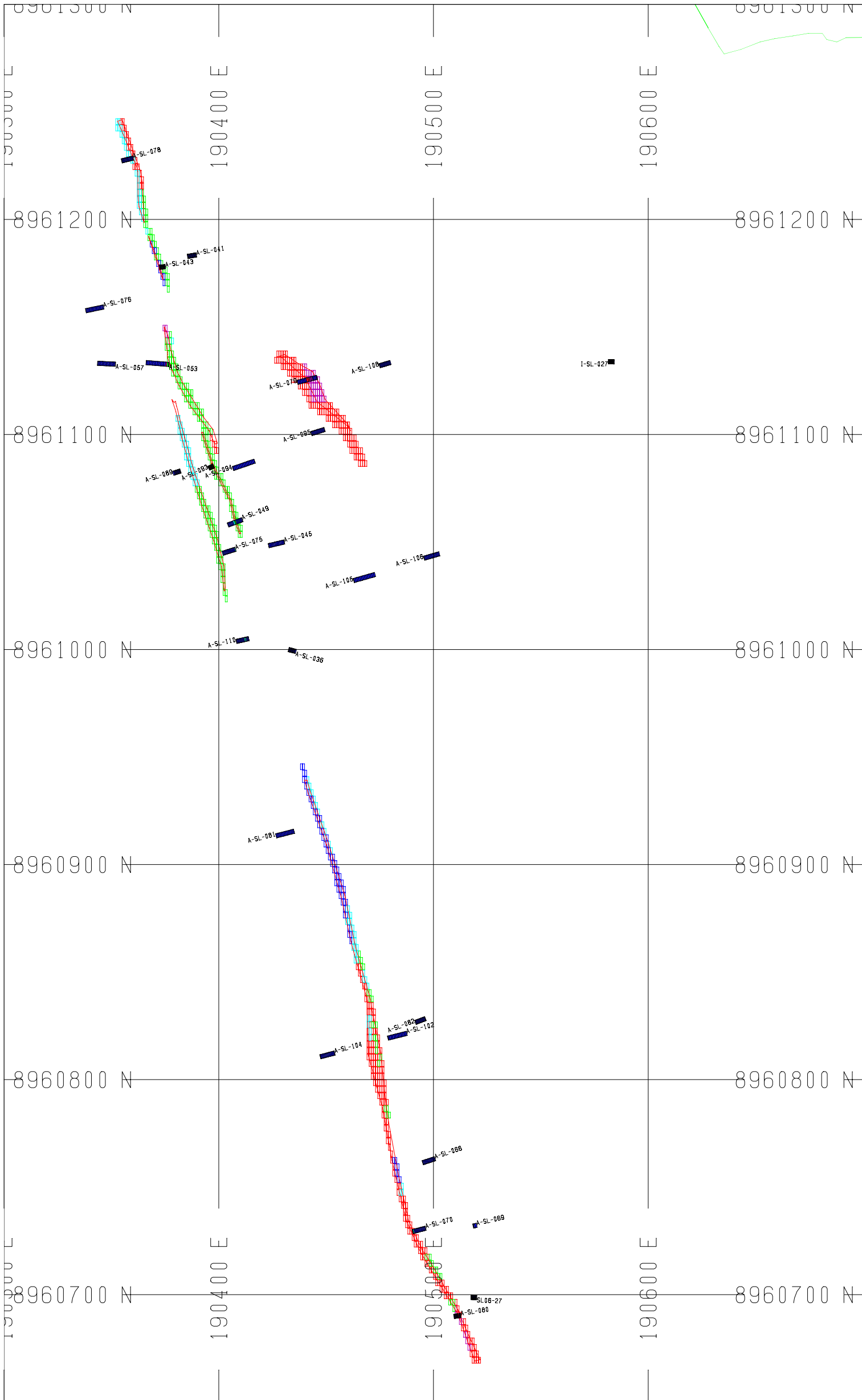

San Luis Project, Peru

Silver Bench Level Plan

4350 Elevation

DATE	SCALE	FILE
Dec 09, 2008	1:2000	4350 Elevation.pdf

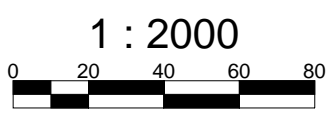
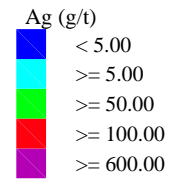

1 : 2000